



i3300

LABEL PRINTER

Print any label or sign with the versatile BradyPrinter i3300 Industrial Label Printer

About BRADY



Once you have worked with BRADY, our name will stick with you, (just like our labels) because BRADY is one of the world's leading labelling and identification specialists.

Innovative

At BRADY we continue to improve. We have many customers from all industries, and we strive to be ahead of their needs by continuing to invest in research for even more performant solutions. By developing more user-friendly and efficient concepts, we give our thousands of customers the best in the market.

Strength

At BRADY, we believe our biggest strength is the wide range of identification and safety solutions we can offer our customers, whether it's labelling the smallest component or complete signage for an entire warehouse. We're also proud to offer many products and services - from printers, scanners and software to service contracts and on-site training - that compliment any identification job. And don't forget, our wide network of expert distributors can always offer you a tailor-made solution to meet your specific requirements.

Trust

For over a hundred years, BRADY has been connected with quality, trust and stability. We demand the best for your products and services, because we know, better than anyone, the importance of good and reliable identification. Identification looks like a small detail, but every professional knows that this kind of detail is crucial to any business.

Inform

We also have specialised dealers in your region, who can answer all your identification and labelling questions, specific to your activity. They will be happy to provide you with all kinds of options and solutions with no obligation.

Microsoft is a trademark of Microsoft Corporation, Bluetooth is a trademark of Bluetooth Sig, Inc., Android is a trademark of Google Inc.



Brady products are sold on the condition that the purchaser will test them in actual use and determine for himself/herself their suitability to his/her intended purpose. Brady warrants to the purchaser that Brady products are free from defects in material and workmanship but limits its obligation under this warranty to the replacement of the product which has been shown to Brady's satisfaction to have been defective at the time of its purchase.

The warranty does not extend to any persons who have acquired the product from the purchaser. It is in lieu of any other warranty, including every warranty of sale-ability, marketability or suitability for the intended purpose, and is also in lieu of any other obligation or liability on the part of Brady.

Under no circumstances will Brady be liable for losses, damage, costs or subsequent damage of whatever nature which may arise in connection with the use of, or inability to use, Brady's products.

Print any label or sign with the versatile BradyPrinter i3300 Industrial Label Printer

The Brady Advantage

When it comes to identification, safety and compliance, there's a clear advantage to working with Brady. We put our customers first in everything we do.

Our goal is to give you an unrivalled customer experience. We are relentlessly committed to performance and excellence - in our products, services and people.

Our products and solutions perform in ways that others simply can't match. Our people perform in ways that regularly exceed your expectations. And our focus and discipline work toward solid, long-term performance for our customers.

In short, Brady is the company you trust when performance matters most.

Learn more about the Brady Advantage at: www.bradyeurope.com

Table of contents

| | |
|----|--|
| 4 | BradyPrinter i3300 introduction |
| 5 | BradyPrinter i3300 at a glance |
| 6 | BradyPrinter i3300 kits and accessories |
| 7 | Applications |
| 9 | Media offering |
| 10 | Ribbons |
| 11 | Facility & safety identification |
| 20 | Electrical / Automation identification |
| 33 | Product & general purpose identification |
| 38 | Electronics identification |
| 41 | Laboratory identification |
| 49 | Master material index |
| 54 | Software |
| 55 | BradyPrinter i3300 specifications |



BradyPrinter i3300
Industrial Label Printer



Compatible labels & ribbons

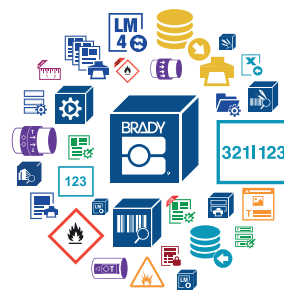

Software for label creation
and data integration



Printer technical specifications

Print any label or sign with the versatile BradyPrinter i3300 Industrial Label Printer

The BradyPrinter i3300 Industrial Label Printer is a completely hassle free, easy to use PC-based printer. It can print a full range of safety and facility labels and signs as well as die cut labels for wire identification, product identification and laboratory identification.



Print a huge range of labels & signs

With the BradyPrinter i3300, you can print a huge range of reliable labels and signs at your location in monocolour. More than 50 different Brady label materials are compatible with the BradyPrinter i3300. Labels & signs that can be printed with the BradyPrinter i3300 include:

- wire & cable identification labels
- product and laboratory identification labels
- safety and facility signs

These can be used both in- and outdoor, and include specialty solutions like ToughWash labels and ToughStripe floor marking.

Designed to last

The BradyPrinter i3300 prints on Brady's industrial grade labels that have been designed to last in challenging conditions. All Brady labels have been tested in line with international ASTM test methods and a technical data sheet is available for every material.

[Scan or click the QR code](#)



Extremely easy to use

The BradyPrinter i3300 is extremely easy to use and features auto-calibration and automatic label material setup. This will enable you to immediately start printing the signs and labels you need. Switching to another label material is easy and extremely fast thanks to the printer's 'drop-in' label materials and matching ink ribbons that can be switched out in less than 20 seconds. When used with Brady Workstation apps, a wide variety of sign & label design options becomes available.

BradyPrinter i3300 top features



No wasting labels with print smart technology

Print on every label or sleeve – no more blank first label. With print smart technology, the printer, labels, ribbons and software all work together for efficient label setup. It's all in the smart chip embedded in Brady materials – it stores the material size, type, colour, quantity and compatibility, and sets proper burn settings, sensor alignment and print speed. When installed, the chip sends that information to the printer and desktop software and auto calibrates without wasting any labels – and you get fast material setup and creation, without the waste.



Get no-hassle, 20-second material changeovers

Forget fumbling around with ribbon rolls that are great at rolling away or threading material around rollers or print heads. Switch to a new way of material changeovers with the BradyPrinter i3300 Industrial Label Printer. The easy-to-load label rolls and self-contained ribbons snap into place for easy 20-second material changeovers without cumbersome sensor adjustments. Switch materials frequently throughout the day? You'll save time to work on your more important tasks.

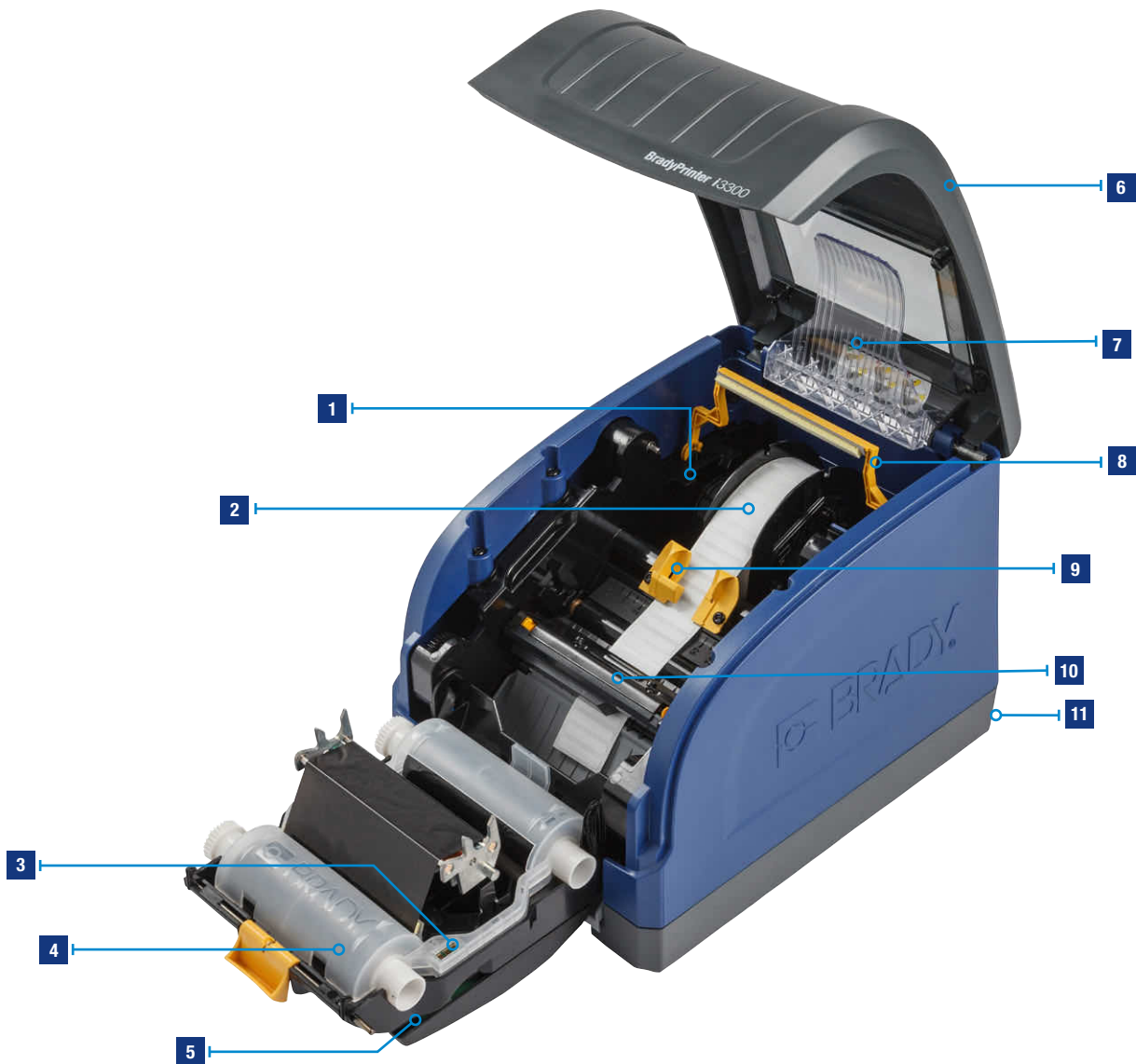

1 Media roll cartridge with auto part detection

Printer auto-detects installed label part, communicating printer setting and part setup information to both printer and Brady software

2 20-second media roll changeover

Media cartridge roll drops in and out of place quickly with minimal thread-through, no sensor adjustment, no calibration and no label waste

3 Ribbon cartridge with auto part detection

Printer auto-detects installed ribbon part, then sets correct print heat level and shows a warning if incorrect ribbon is used

4 5-second ribbon changeover

Ribbon cartridge snaps into place in one quick motion and guarantees the ink always faces the right direction to the print head

5 Color touchscreen control panel

Icons and sliders for easy printer setting adjustments and on-display part information and amount remaining

6 Top-loading design

Reduces footprint in your work area and simplifies media alignment and loading

7 Double-sided PermaSleeve bridge

Lowered into place to allow printing second side of double-sided PermaSleeve wire markers

8 Media wiper arm

Ensures dust-free surface and high print quality when printing large ink areas on continuous media. Felt pads are field-replaceable

9 Sensors located in guides

Label sensor is always correctly positioned as guides are closed, meaning no sensor location trial and error, no calibration required and no wasted labels

10 Integrated auto cutter

Built-in cutter for complete cut-through of media between labels, at end of job, or no cut at all

11 Interface options

2x USB, 1x USB 2.0, 1x Ethernet (back of printer)

Printer

| Article No. | Order Ref. | Description |
|-------------|--------------------|--|
| 149553 | I3300-C-EU | i3300 Industrial Label Printer- EU |
| 241130 | I3300-C-EU-LAB | i3300 Industrial Label Printer- EU with Brady Workstation LAB Suite |
| 241124 | I3300-C-EU-PWI | i3300 Industrial Label Printer- EU with Brady Workstation PWID Suite |
| 241118 | I3300-C-EU-SFI | i3300 Industrial Label Printer- EU with Brady Workstation SFID Suite |
| 149555 | I3300-C-UK | i3300 Industrial Label Printer- UK |
| 241132 | I3300-C-UK-LAB | i3300 Industrial Label Printer- UK with Brady Workstation LAB Suite |
| 241126 | I3300-C-UK-PWI | i3300 Industrial Label Printer- UK with Brady Workstation PWID Suite |
| 241120 | I3300-C-UK-SFI | i3300 Industrial Label Printer- UK with Brady Workstation SFID Suite |
| 149551 | I3300-300-C-US | i3300 Industrial Label Printer- US |
| 241128 | I3300-C-US-LABS | i3300 Industrial Label Printer- US with Brady Workstation LAB Suite |
| 241122 | I3300-C-US-PWID | i3300 Industrial Label Printer- US with Brady Workstation PWID Suite |
| 241116 | I3300-C-US-SFIDS | i3300 Industrial Label Printer- US with Brady Workstation SFID Suite |
| 149554 | I3300-C-EU-WF | i3300 Industrial Label Printer with Wifi- EU |
| 241131 | I3300-C-EU-W-L | i3300 Industrial Label Printer with Wifi- EU with Brady Workstation LAB Suite |
| 241125 | I3300-C-EU-W-P | i3300 Industrial Label Printer with Wifi- EU with Brady Workstation PWID Suite |
| 241119 | I3300-C-EU-W-S | i3300 Industrial Label Printer with Wifi- EU with Brady Workstation SFID Suite |
| 149556 | I3300-C-UK-WF | i3300 Industrial Label Printer with Wifi- UK |
| 241133 | I3300-C-UK-W-L | i3300 Industrial Label Printer with Wifi- UK with Brady Workstation LAB Suite |
| 241127 | I3300-C-UK-W-P | i3300 Industrial Label Printer with Wifi- UK with Brady Workstation PWID Suite |
| 241121 | I3300-C-UK-W-S | i3300 Industrial Label Printer with Wifi- UK with Brady Workstation SFID Suite |
| 149552 | I3300-300-C-US-WF | i3300 Industrial Label Printer with Wifi- US |
| 241129 | I3300-C-US-W-LABS | i3300 Industrial Label Printer with Wifi- US with Brady Workstation LAB Suite |
| 241123 | I3300-C-US-W-PWID | i3300 Industrial Label Printer with Wifi- US with Brady Workstation PWID Suite |
| 241117 | I3300-C-US-W-SFIDS | i3300 Industrial Label Printer with Wifi- US with Brady Workstation SFID Suite |



This i3300 printer comes in a cardboard box. It ships with a power cord, a Brady Workstation Suite, a USB cable, a product CD holding the manual, a cleaning kit and a printed quick start guide.

Accessories

| Article No. | Order Ref. | Description |
|-------------|-----------------------------------|---|
| 036612 | Squeegee | Squeegee |
| 120994 | B30-TROLLEY | Trolley for BBP3x,S3xxx,i3300 |
| 133251 | PCK-6 | Printer Cleaning Kit, Thermal Transfer Printers |
| 142114 | B31-WIPER | Media Wiper 5 Pack |
| 142115 | ASSY, PKG, ACCESSORY, STYLUS, PLA | Replacement Stylus 3 Pack |
| 142116 | B31-CCT | Cutter Cleaning Tool for BBP30, BBP31, BBP33, S3100 and i3300 printer |



120994



036612



142116



142114



133251



142115

Printer kits

| Article No. | Order Ref. | Description |
|-------------|----------------|--|
| 199986 | B30-FLOOR-KIT | Floor marking kit for BBP35/BBP37/S3xxx/i3300 printers |
| 195963 | B30-SAFETY-KIT | General safety kit for BBP3x Printers |
| 195962 | B30-PM-KIT | Pipe marking kit for BBP3x Printers |
| 195961 | B30-CLP-KIT | Pre-printed GHS/CLP Chemical Labels kit for BBP3x Printers |



195961



195963



199986



195962

Facility & Safety Identification



Safety signs



Pipe markers



Machine safety labels and tags



CLP/GHS Labels



Warehouse identification



Floormarking

Electrical, voice/datacom identification



Control panel labels

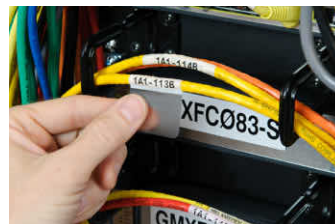

Self-laminating wire & cable markers



Inside panel component labels



Fibre optic cable markers



Cable tags



Wire marking sleeves

General & industrial identification



Rating plate labels



Name plates



Rough surface labels

Electronics identification



Electronic component labels



High resistant labels



Static dissipative labels

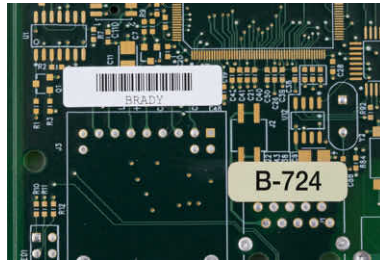

High-temperature identification labels

Laboratory identification & sample tracking



Centrifuge & PCR tube labels



Conical & large tube labels

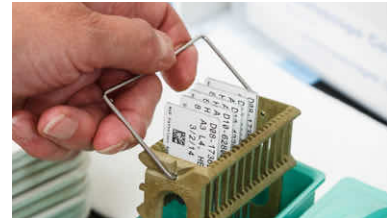

Slide labels



Tissue cassette labels



Water dissolvable labels



Well plate labels

We continuously try to improve & extend our label material offering, therefore make sure to check for firmware upgrades regularly, in order to make sure you always have access to the newest materials.

| Material | | Material | | Material | |
|--------------|---|--------------|---------------------------------------|----------|--------------------------------------|
| B-342 | Heat-shrink Polyolefin Sleeve | B-480A | Metallic, Non-metal Polyester | B-618 | Polyester |
| B-345 | High Temperature Heat-shrink Polyvinylidene Fluoride Sleeve | B-481 | StainerBondz™ Polyester | B-717 | Polyimide |
| B-348 | Polyolefin | B-482 | Polyester | B-718 | Polyimide |
| B-413 | Metallic, Non-metal Polyester | B-483A | Polyester | B-719 | Polyimide |
| B-417 | Self-laminating Vinyl | B-483A | Polyester | B-724 | Polyimide |
| B-422 | Polyester | B-483A/B-634 | Polyester with Polyester Overlaminate | B-727 | Polyimide |
| B-423 | Polyester | B-486B | Metallised Polyester | B-728 | Polyimide |
| B-424 | Paper | B-488 | Polyester | B-729 | Polyimide |
| B-425A | Polypropylene | B-489A | Polyester | B-7425 | Polypropylene |
| B-427 | Self-laminating Vinyl | B-490 | FreezerBondz™ Polyester | B-7563 | Metallised Polyester |
| B-428 | Metallised Polyester | B-492 | FreezerBondz™ Polyester | B-7569 | Vinyl |
| B-428/B-966B | Metallised Polyester with Polyester Overlaminate | B-498 | Vinyl Cloth | B-7597 | Polyethylene Tag |
| B-430 | Polyester | B-499 | Nylon Cloth | B-7598 | Polyester Tag |
| B-432 | Polyester | B-509 | Magnetic Polyester | B-7599 | Polyethylene Tag |
| B-434A | Metallised Polyester | B-526 | Phosphorescent Polyester | B-7641 | Heat-shrink Polyolefin Sleeve |
| B-435A | Metallised Polyester | B-549 | Polyester | B-7642 | Heat-shrink Polyolefin Sleeve |
| B-437 | Polyvinylfluoride | B-551 | Polyester Tag | B-7643 | Thermoplastic Polyether Polyurethane |
| B-438 | Tamper-evident Metallised Polyester | B-565 | Metallised Polyester | B-7696 | Vinyl Tag |
| B-439 | Vinyl | B-569 | Polyester | B-777 | Polyimide |
| B-461 | Self-laminating Polyester | B-581 | Vinyl | B-787 | Polyvinylfluoride |
| B-472 | Polyimide | B-584 | Reflective Tape | B-8423 | Polyester |
| | | B-593 | Polyester | B-854 | Metal Detectable Polyester |
| | | B-595 | Vinyl | B-855 | Polyester |
| | | | | B-8591 | Polymer |

Next to 800+ standard parts available including more than 51 label materials, customers can also offer their own label specification for custom materials, shapes, sizes, colours and layouts that can be printed on the BradyPrinter i3300.

Print ribbons

“Drop & Click” Print ribbons for quick and easy supply changes

| Order Reference | Colour | Width (mm) x Length (m) |
|-----------------|--------|-------------------------|
| B30-R10000 | Black | 110.00 x 60.00 |
| B30-R10000-BL | Blue | 110.00 x 60.00 |
| B30-R10000-GN | Green | 110.00 x 60.00 |
| B30-R10000-OR | Orange | 110.00 x 60.00 |
| B30-R10000-RD | Red | 110.00 x 60.00 |
| B30-R10000-WT | White | 110.00 x 60.00 |
| B30-R10000-YL | Yellow | 110.00 x 60.00 |
| B30-R6000HF | Black | 110.00 x 60.00 |
| B30-R4300 | Black | 110.00 x 60.00 |
| B30-R6600 | Black | 110.00 x 60.00 |
| B30-R4400-WT | White | 110.00 x 60.00 |
| B30-R4500* | Silver | 110.00 x 60.00 |
| B30-R6700-WT | White | 110.00 x 60.00 |
| B30-R6400 | Black | 110.00 x 60.00 |
| B30-R6200 | Black | 110.00 x 60.00 |
| B30-R10000-YL2 | Yellow | 110.00 x 60.00 |
| B30-R6000OC | Black | 110.00 x 60.00 |
| B30-R6300 | Black | 110.00 x 60.00 |

- Tough, smear-proof ribbons that produce
- long-lasting printed text
- Print can withstand years in industrial areas and outdoor conditions
- Ribbons supplied in self-contained cartridges that drop straight into the printer with a “click”
- No calibrating, no threading, no waste, no hassle and the ink will always be facing the right direction
- Printer notifies user if installed ribbon is not recommended for the installed labels



*This ribbon is for use with B-342 and B-345 black PermaSleeves only

**For printing yellow onto white B-595 use B30-R10000-YL. For printing yellow onto other colours of B-595 use B30-R10000-YL2

***Black Heavy-Duty print ribbon to print Ochre B-595

i3300 Print ribbon/material compatibility

| B Number | Material | | B30- R4300 Black | B30- R4400-WT White | B30- R4500* Silver | B30- R6000HF Black | B30- R6200 Black | B30- R6400 Black | B30- R6600 Black | B30- R6700-WT White | B30- R10000 Black | B30- R10000-WT White | B30- R10000 Blue | B30- R10000-YL2** Yellow |
|--------------|---|------------|------------------------|---------------------------|--------------------------|--------------------------|------------------------|------------------------|------------------------|---------------------------|-------------------------|----------------------------|------------------------|--------------------------------|
| B-342 | Heat-shrink Polyolefin Sleeve | Matt | | | | | | | | | | | | |
| B-345 | High Temperature Heat-shrink Polyvinylidene Fluoride Sleeve | Matt | | ✓ | | ✓ | | | ✓ | | | | | |
| B-413 | Metallic, Non-metal Polyester | Satin | | | | | | | | | | | | |
| B-417 | Self-laminating Vinyl | Matt | | | | | | | | | | | | |
| B-422 | Polyester | Gloss | | | | ✓ | ✓ | | | | | | | |
| B-423 | Polyester | Gloss | | | | ✓ | ✓ | | | | | | | |
| B-424 | Paper | Matt | ✓ | | | | | | | | | | | |
| B-425A | Polypropylene | Matt | ✓ | | | | | ✓ | | | | | | |
| B-427 | Self-laminating Vinyl | Matt | | | | | | | | | | | | |
| B-428/B-966B | Metallised Polyester with Polyester Overlaminates | Gloss | | | | | | | | | | | | |
| B-428 | Metallised Polyester | Matt | ✓ | | | | | | | | | | | |
| B-430 | Polyester | Gloss | | ✓ | | ✓ | ✓ | | | | | | | |
| B-432 | Polyester | Gloss | | ✓ | | ✓ | | | | | | | | |
| B-434A | Metallised Polyester | Gloss | | | | ✓ | | | | | | | | |
| B-435A | Metallised Polyester | Gloss | | | | ✓ | | | | | | | | |
| B-437 | Polyvinylfluoride | Matt | ✓ | | | | | | | | | | | |
| B-438 | Tamper-evident Metallised Polyester | Matt | ✓ | | | | | | | | ✓ | | | |
| B-461 | Self-laminating Polyester | Matt | ✓ | | | | ✓ | | | | | | | |
| B-472 | Polyimide | Matt | ✓ | | | | ✓ | | | | | | | |
| B-481 | StainerBondz™ Polyester | Matt | | | | | | ✓ | | | | | | |
| B-482 | Polyester | Matt | | | | | | ✓ | | | | | | |
| B-483A | Polyester | Gloss | | | | ✓ | | | | | | | | |
| B-484A | Polyester | Gloss | | | | ✓ | | | | | | | | |
| B-486B | Metallised Polyester | Matt | ✓ | | | | | | | | | | | |
| B-488 | Polyester | Matt | ✓ | | | | | | | | | | | |
| B-489A | Polyester | Matt | ✓ | | | | | | | | | | | |
| B-490 | FreezerBondz™ Polyester | Matt | ✓ | | | | | | | | | | | |
| B-492 | FreezerBondz™ Polyester | Matt | | | | | | ✓ | | | | | | |
| B-498 | Vinyl Cloth | Semi-gloss | ✓ | | | | ✓ | | | | | | | |
| B-499 | Nylon Cloth | Matt | | | | | | | | | | | | |
| B-509 | Magnetic Polyester | Matt | | | | ✓ | | | | | ✓ | | ✓ | |
| B-526 | Phosphorescent Polyester | Gloss | | | | ✓ | | | | | ✓ | | ✓ | |
| B-549 | Polyester | Gloss | | | | | | | ✓ | | ✓ | ✓ | ✓ | |
| B-551 | Polyester Tag | Matt | | | | ✓ | | | | | ✓ | | ✓ | |
| B-565 | Metallised Polyester | Matt | | | | ✓ | | | | | ✓ | | ✓ | |
| B-569 | Polyester | Gloss | | | | ✓ | | | | | ✓ | ✓ | ✓ | |
| B-581 | Vinyl | Gloss | | | | ✓ | | | | | ✓ | ✓ | ✓ | |
| B-584 | Reflective Tape | Gloss | | | | ✓ | | | | | ✓ | | ✓ | |
| B-593 | Polyester | Gloss | | ✓ | | ✓ | | | | | | | | |
| B-595 | Vinyl | Gloss | | | | ✓ | | | | ✓ | ✓ | ✓ | ✓ | ✓ |
| B-717 | Polyimide | Gloss | | | | ✓ | | | | | | | | |
| B-718 | Polyimide | Gloss | | | | ✓ | | | | | | | | |
| B-719 | Polyimide | Matt | | | | ✓ | | | | | | | | |
| B-724 | Polyimide | Matt | ✓ | | | | | | | | | | | |
| B-727 | Polyimide | Gloss | | | | ✓ | | | | | | | | |
| B-728 | Polyimide | Matt | | | | | | | | | | | | |
| B-729 | Polyimide | Matt | | | | | | | | | | | | |
| B-777 | Polyimide | Gloss | | | | | | | | | | | | |
| B-854 | Metal Detectable Polyester | Matt | | | | ✓ | | | | | | | | |
| B-855 | Polyester | Matt | | | | ✓ | | | | | | | | |
| B-7563 | Metallised Polyester | Satin | | | | ✓ | ✓ | | | | | | | |
| B-7569 | Vinyl | Gloss | | | | ✓ | | | | | ✓ | ✓ | ✓ | |
| B-7597 | Polyethylene Tag | Matt | ✓ | | | | | | | | | | | |
| B-7641 | Heat-shrink Polyolefin Sleeve | Matt | | | | ✓ | | | | | | | | |
| B-7642 | Heat-shrink Polyolefin Sleeve | Matt | ✓ | | | | | ✓ | | | | | | |
| B-8423 | Polyester | Satin | | | | ✓ | ✓ | | | | | | | |
| B-8591 | Polymer | Gloss | | | | | | | | | | | | |

*This ribbon is for use with B-342 and B-345 Black PermaSleeves only **For printing yellow onto white B-595 use B30-R10000-YL. For printing yellow onto other colours of B-595 use B30-R10000-YL2

Pre-printed Pre-cut blank sign headers

For creating Arc Flash and safety warning labels in seconds

- Allows the printer to create multi-colour signs fast - in a single print pass
- B-595 Indoor/Outdoor grade material conforms to rough, irregular and “difficult to adhere to” surfaces
- B-483 uses an aggressive adhesive specifically designed for powder coated surfaces



| Diagram | Order Reference | | Label Width A (mm) | Label Height B (mm) | Vertical Repeat D (mm) | Labels per Roll | Printer Ribbon Series |
|--------------------------|---------------------|--|--------------------|---------------------|------------------------|-----------------|-----------------------|
| B-483A: Polyester | | | | | | | |
| ⊗ | B33-184-483-ANSIWA | | 76.20 | 76.20 | 82.55 | 500 | B30 Monocolour Series |
| ⊗ | B33-184-483-ANSIDA | | 76.20 | 76.20 | 82.55 | 500 | B30 Monocolour Series |
| ⊗ | B33-161-483-ANSIDA | | 101.60 | 101.60 | 107.95 | 370 | B30 Monocolour Series |
| ⊗ | B33-161-483-ANSIWA | | 101.60 | 101.60 | 107.95 | 370 | B30 Monocolour Series |
| B-595: Vinyl | | | | | | | |
| ▲ | B30-242-595-BLNKWT | | 28.58 | 72.39 | 82.55 | 300 | B30-R10000 |
| ⊗ | B30-241-595-ANSIDA | | 76.20 | 57.15 | 82.55 | 300 | B30-R10000 |
| ⊗ | B30-241-595-ANSICA | | 76.20 | 57.15 | 82.55 | 300 | B30-R10000 |
| ⊗ | B30-241-595-ANSIWA | | 76.20 | 57.15 | 82.55 | 300 | B30-R10000 |
| ⊗ | B30-241-595-ANSINO | | 76.20 | 57.15 | 82.55 | 300 | B30-R10000 |
| ⊗ | B30-241-595-OSHADA | | 76.20 | 57.15 | 82.55 | 300 | B30-R10000 |
| ⊗ | B30-241-595-OSHACA* | | 76.20 | 57.15 | 82.55 | 300 | B30-R10000 |
| ▲ | B30-241-595-BLNKWT | | 76.20 | 57.15 | 82.55 | 300 | B30-R10000 |
| ▲ | B30-241-595-BLNKYL | | 76.20 | 57.15 | 82.55 | 300 | B30-R10000 |
| ▲ | B30-219-595-BLNKWT | | 97.79 | 57.15 | 107.95 | 250 | B30-R10000 |
| ⊗ | B30-25-595-ANSIDA | | 152.40 | 101.60 | 158.75 | 175 | B30-R10000 |
| ⊗ | B30-25-595-ANSICA | | 152.40 | 101.60 | 158.75 | 175 | B30-R10000 |
| ⊗ | B30-25-595-ANSIWA | | 152.40 | 101.60 | 158.75 | 175 | B30-R10000 |
| ⊗ | B30-25-595-ANSINO | | 152.40 | 101.60 | 158.75 | 175 | B30-R10000 |
| ⊗ | B30-25-595-OSHADA | | 152.40 | 101.60 | 158.75 | 175 | B30-R10000 |
| ⊗ | B30-25-595-OSHACA* | | 152.40 | 101.60 | 158.75 | 175 | B30-R10000 |
| ▲ | B30-25-595-BLNKWT | | 152.40 | 101.60 | 158.75 | 175 | B30-R10000 |
| ▲ | B30-25-595-BLNKYL | | 152.40 | 101.60 | 158.75 | 175 | B30-R10000 |

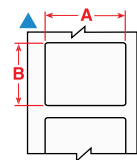
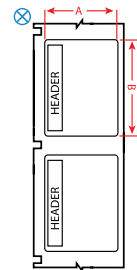

B-551 Non-adhesive pre-printed & pre-cut safety tags

Pre-printed and pre-cut to save you time

- Non-adhesive semi-rigid polyester card stock
- Tags are pre-cut with hole and chamfered corners
- Perforated between tags
- Snap-in plastic grommets available for extra strength around mounting hole. Order reference: 020596



| Diagram | Order Reference | | Label Width A (mm) | Label Height B (mm) | Vertical Repeat D (mm) | Labels per Roll | Printer Ribbon Series |
|-------------------------|--------------------|--|--------------------|---------------------|------------------------|-----------------|-----------------------|
| B-551: Polyester | | | | | | | |
| ⊗ | B30-255-551-ANSIDA | | 82.55 | 146.05 | 158.75 | 100 | B30-R10000 |
| ⊗ | B30-255-551-OSHADA | | 82.55 | 146.05 | 158.75 | 100 | B30-R10000 |
| ⊗ | B30-255-551-ANSICA | | 82.55 | 146.05 | 158.75 | 100 | B30-R10000 |

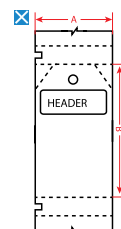

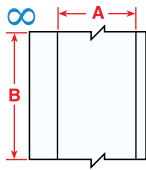

B-595 High performance indoor/outdoor vinyl

For general facility and safety identification:
our best industrial vinyl yet

- Durable, low-shrink vinyl with our most aggressive adhesive
- Conforms to irregular, curved, rough and highly textured surfaces (painted cinder blocks, uneven wood, textured plastics, paper-jacketed pipes, powder-coated surfaces)
- Adheres to “difficult low-surface energy items (PVC piping, blow-moulded equipment cases, ABS plastics, recycled plastics)

| Diagram | Order Reference | Colour | Label Width A (mm) | Label Length B (m) | Labels per Roll | Printer Ribbon Series |
|--------------|------------------|-------------|--------------------|--------------------|-----------------|-----------------------|
| B-595: Vinyl | | | | | | |
| ∞ | B30C-500-595-BK | Black | 12.70 | 30.48 | 1 | B30-R10000-WT |
| ∞ | B30C-500-595-BL | Blue | 12.70 | 30.48 | 1 | B30-R10000-WT |
| ∞ | B30C-500-595-BR | Brown | 12.70 | 30.48 | 1 | B30-R10000-WT |
| ∞ | B30C-500-595-GD | Gold | 12.70 | 30.48 | 1 | B30-R10000 |
| ∞ | B30C-500-595-GN | Green | 12.70 | 30.48 | 1 | B30-R10000-WT |
| ∞ | B30C-500-595-GY | Grey | 12.70 | 30.48 | 1 | B30-R10000 |
| ∞ | B30C-500-595-OR | Orange | 12.70 | 30.48 | 1 | B30-R10000 |
| ∞ | B30C-500-595-PL | Purple | 12.70 | 30.48 | 1 | B30-R10000-WT |
| ∞ | B30C-500-595-RD | Red | 12.70 | 30.48 | 1 | B30-R10000-WT |
| ∞ | B30C-500-595-CL | Transparent | 12.70 | 30.48 | 1 | B30-R10000 |
| ∞ | B30C-500-595-WT | White | 12.70 | 30.48 | 1 | B30-R10000 |
| ∞ | B30C-500-595-YL | Yellow | 12.70 | 30.48 | 1 | B30-R10000 |
| ∞ | B30C-1125-595-BK | Black | 28.58 | 30.48 | 1 | B30-R10000-WT |
| ∞ | B30C-1125-595-BL | Blue | 28.58 | 30.48 | 1 | B30-R10000-WT |
| ∞ | B30C-1125-595-BR | Brown | 28.58 | 30.48 | 1 | B30-R10000-WT |
| ∞ | B30C-1125-595-GD | Gold | 28.58 | 30.48 | 1 | B30-R10000 |
| ∞ | B30C-1125-595-GN | Green | 28.58 | 30.48 | 1 | B30-R10000-WT |
| ∞ | B30C-1125-595-GY | Grey | 28.58 | 30.48 | 1 | B30-R10000 |
| ∞ | B30C-1125-595-OC | Ochre | 28.58 | 30.48 | 1 | B30-R60000C |
| ∞ | B30C-1125-595-OR | Orange | 28.58 | 30.48 | 1 | B30-R10000 |
| ∞ | B30C-1125-595-PL | Purple | 28.58 | 30.48 | 1 | B30-R10000-WT |
| ∞ | B30C-1125-595-RD | Red | 28.58 | 30.48 | 1 | B30-R10000-WT |
| ∞ | B30C-1125-595-CL | Transparent | 28.58 | 30.48 | 1 | B30-R10000 |
| ∞ | B30C-1125-595-WT | White | 28.58 | 30.48 | 1 | B30-R10000 |
| ∞ | B30C-1125-595-YL | Yellow | 28.58 | 30.48 | 1 | B30-R10000 |
| ∞ | B30C-2250-595-BK | Black | 57.15 | 30.48 | 1 | B30-R10000-WT |
| ∞ | B30C-2250-595-BL | Blue | 57.15 | 30.48 | 1 | B30-R10000-WT |
| ∞ | B30C-2250-595-BR | Brown | 57.15 | 30.48 | 1 | B30-R10000-WT |
| ∞ | B30C-2250-595-GD | Gold | 57.15 | 30.48 | 1 | B30-R10000 |
| ∞ | B30C-2250-595-GN | Green | 57.15 | 30.48 | 1 | B30-R10000-WT |
| ∞ | B30C-2250-595-GY | Grey | 57.15 | 30.48 | 1 | B30-R10000 |
| ∞ | B30C-2250-595-OC | Ochre | 57.15 | 30.48 | 1 | B30-R60000C |
| ∞ | B30C-2250-595-OR | Orange | 57.15 | 30.48 | 1 | B30-R10000 |
| ∞ | B30C-2250-595-PL | Purple | 57.15 | 30.48 | 1 | B30-R10000-WT |
| ∞ | B30C-2250-595-RD | Red | 57.15 | 30.48 | 1 | B30-R10000-WT |
| ∞ | B30C-2250-595-CL | Transparent | 57.15 | 30.48 | 1 | B30-R10000 |
| ∞ | B30C-2250-595-WT | White | 57.15 | 30.48 | 1 | B30-R10000 |
| ∞ | B30C-2250-595-YL | Yellow | 57.15 | 30.48 | 1 | B30-R10000 |
| ∞ | B30C-3000-595-WT | White | 76.20 | 30.48 | 1 | B30-R10000 |
| ∞ | B30C-3000-595-YL | Yellow | 76.20 | 30.48 | 1 | B30-R10000 |
| ∞ | B30C-4000-595-BK | Black | 101.60 | 30.48 | 1 | B30-R10000-WT |
| ∞ | B30C-4000-595-BL | Blue | 101.60 | 30.48 | 1 | B30-R10000-WT |
| ∞ | B30C-4000-595-BR | Brown | 101.60 | 30.48 | 1 | B30-R10000-WT |
| ∞ | B30C-4000-595-GD | Gold | 101.60 | 30.48 | 1 | B30-R10000 |
| ∞ | B30C-4000-595-GN | Green | 101.60 | 30.48 | 1 | B30-R10000-WT |
| ∞ | B30C-4000-595-GY | Grey | 101.60 | 30.48 | 1 | B30-R10000 |
| ∞ | B30C-4000-595-OC | Ochre | 101.60 | 30.48 | 1 | B30-R60000C |
| ∞ | B30C-4000-595-OR | Orange | 101.60 | 30.48 | 1 | B30-R10000 |
| ∞ | B30C-4000-595-PL | Purple | 101.60 | 30.48 | 1 | B30-R10000-WT |
| ∞ | B30C-4000-595-RD | Red | 101.60 | 30.48 | 1 | B30-R10000-WT |
| ∞ | B30C-4000-595-CL | Transparent | 101.60 | 30.48 | 1 | B30-R10000 |
| ∞ | B30C-4000-595-WT | White | 101.60 | 30.48 | 1 | B30-R10000 |
| ∞ | B30C-4000-595-YL | Yellow | 101.60 | 30.48 | 1 | B30-R10000 |

B-569 High performance polyester

For labelling stainless steel and smooth surfaces

- Low-halide content for labelling stainless steel pipes and surfaces
- Applies best to very smooth surfaces and ideal for mounting to rigid panels

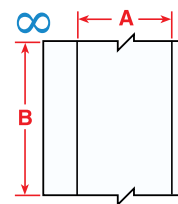

| Diagram | Order Reference | Colour | Label Width A (mm) | Label Length B (m) | Labels per Roll | Printer Ribbon Series |
|-------------------------|------------------|-------------|--------------------|--------------------|-----------------|-----------------------|
| B-569: Polyester | | | | | | |
| ∞ | B30C-500-569-BK | Black | 12.70 | 30.48 | 1 | B30-R10000-WT |
| ∞ | B30C-500-569-BL | Blue | 12.70 | 30.48 | 1 | B30-R10000-WT |
| ∞ | B30C-500-569-BR | Brown | 12.70 | 30.48 | 1 | B30-R10000-WT |
| ∞ | B30C-500-569-GN | Green | 12.70 | 30.48 | 1 | B30-R10000-WT |
| ∞ | B30C-500-569-GY | Grey | 12.70 | 30.48 | 1 | B30-R10000 |
| ∞ | B30C-500-569-LB | Light Blue | 12.70 | 30.48 | 1 | B30-R10000 |
| ∞ | B30C-500-569-OC | Ochre | 12.70 | 30.48 | 1 | B30-R10000 |
| ∞ | B30C-500-569-OR | Orange | 12.70 | 30.48 | 1 | B30-R10000 |
| ∞ | B30C-500-569-PK | Pink | 12.70 | 30.48 | 1 | B30-R10000 |
| ∞ | B30C-500-569-PL | Purple | 12.70 | 30.48 | 1 | B30-R10000-WT |
| ∞ | B30C-500-569-RD | Red | 12.70 | 30.48 | 1 | B30-R10000-WT |
| ∞ | B30C-500-569-SB | Sky Blue | 12.70 | 30.48 | 1 | B30-R10000 |
| ∞ | B30C-500-569-TN | Tan | 12.70 | 30.48 | 1 | B30-R10000 |
| ∞ | B30C-500-569-CL | Transparent | 12.70 | 30.48 | 1 | B30-R10000 |
| ∞ | B30C-500-569-WT | White | 12.70 | 30.48 | 1 | B30-R10000 |
| ∞ | B30C-500-569-YL | Yellow | 12.70 | 30.48 | 1 | B30-R10000 |
| ∞ | B30C-1125-569-BK | Black | 28.58 | 30.48 | 1 | B30-R10000-WT |
| ∞ | B30C-1125-569-BL | Blue | 28.58 | 30.48 | 1 | B30-R10000-WT |
| ∞ | B30C-1125-569-BR | Brown | 28.58 | 30.48 | 1 | B30-R10000-WT |
| ∞ | B30C-1125-569-GN | Green | 28.58 | 30.48 | 1 | B30-R10000-WT |
| ∞ | B30C-1125-569-GY | Grey | 28.58 | 30.48 | 1 | B30-R10000 |
| ∞ | B30C-1125-569-LB | Light Blue | 28.58 | 30.48 | 1 | B30-R10000 |
| ∞ | B30C-1125-569-OC | Ochre | 28.58 | 30.48 | 1 | B30-R10000 |
| ∞ | B30C-1125-569-OR | Orange | 28.58 | 30.48 | 1 | B30-R10000 |
| ∞ | B30C-1125-569-PK | Pink | 28.58 | 30.48 | 1 | B30-R10000 |
| ∞ | B30C-1125-569-PL | Purple | 28.58 | 30.48 | 1 | B30-R10000-WT |
| ∞ | B30C-1125-569-RD | Red | 28.58 | 30.48 | 1 | B30-R10000-WT |
| ∞ | B30C-1125-569-SB | Sky Blue | 28.58 | 30.48 | 1 | B30-R10000 |
| ∞ | B30C-1125-569-TN | Tan | 28.58 | 30.48 | 1 | B30-R10000 |
| ∞ | B30C-1125-569-CL | Transparent | 28.58 | 30.48 | 1 | B30-R10000 |
| ∞ | B30C-1125-569-WT | White | 28.58 | 30.48 | 1 | B30-R10000 |
| ∞ | B30C-1125-569-YL | Yellow | 28.58 | 30.48 | 1 | B30-R10000 |
| ∞ | B30C-2250-569-BK | Black | 57.15 | 30.48 | 1 | B30-R10000-WT |
| ∞ | B30C-2250-569-BL | Blue | 57.15 | 30.48 | 1 | B30-R10000-WT |
| ∞ | B30C-2250-569-BR | Brown | 57.15 | 30.48 | 1 | B30-R10000-WT |
| ∞ | B30C-2250-569-GN | Green | 57.15 | 30.48 | 1 | B30-R10000-WT |
| ∞ | B30C-2250-569-GY | Grey | 57.15 | 30.48 | 1 | B30-R10000 |
| ∞ | B30C-2250-569-LB | Light Blue | 57.15 | 30.48 | 1 | B30-R10000 |
| ∞ | B30C-2250-569-OC | Ochre | 57.15 | 30.48 | 1 | B30-R10000 |
| ∞ | B30C-2250-569-OR | Orange | 57.15 | 30.48 | 1 | B30-R10000 |
| ∞ | B30C-2250-569-PK | Pink | 57.15 | 30.48 | 1 | B30-R10000 |
| ∞ | B30C-2250-569-PL | Purple | 57.15 | 30.48 | 1 | B30-R10000-WT |
| ∞ | B30C-2250-569-RD | Red | 57.15 | 30.48 | 1 | B30-R10000-WT |
| ∞ | B30C-2250-569-SB | Sky Blue | 57.15 | 30.48 | 1 | B30-R10000 |
| ∞ | B30C-2250-569-TN | Tan | 57.15 | 30.48 | 1 | B30-R10000 |
| ∞ | B30C-2250-569-CL | Transparent | 57.15 | 30.48 | 1 | B30-R10000 |
| ∞ | B30C-2250-569-WT | White | 57.15 | 30.48 | 1 | B30-R10000 |
| ∞ | B30C-2250-569-YL | Yellow | 57.15 | 30.48 | 1 | B30-R10000 |
| ∞ | B30C-3000-569-WT | White | 76.20 | 30.48 | 1 | B30-R10000 |
| ∞ | B30C-4000-569-BK | Black | 101.60 | 30.48 | 1 | B30-R10000-WT |
| ∞ | B30C-4000-569-BL | Blue | 101.60 | 30.48 | 1 | B30-R10000-WT |
| ∞ | B30C-4000-569-BR | Brown | 101.60 | 30.48 | 1 | B30-R10000-WT |
| ∞ | B30C-4000-569-GN | Green | 101.60 | 30.48 | 1 | B30-R10000-WT |
| ∞ | B30C-4000-569-GY | Grey | 101.60 | 30.48 | 1 | B30-R10000 |
| ∞ | B30C-4000-569-LB | Light Blue | 101.60 | 30.48 | 1 | B30-R10000 |
| ∞ | B30C-4000-569-OC | Ochre | 101.60 | 30.48 | 1 | B30-R10000 |
| ∞ | B30C-4000-569-OR | Orange | 101.60 | 30.48 | 1 | B30-R10000 |

>>

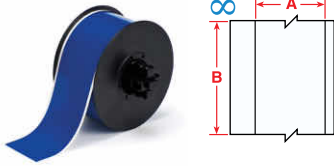

B-569 High performance polyester (Continued)

For labelling stainless steel and smooth surfaces



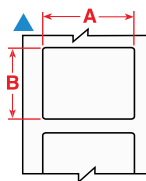







| Diagram | Order Reference | Colour | Label Width A (mm) | Label Length B (m) | Labels per Roll | Printer Ribbon Series |
|---------|------------------|-------------|--------------------|--------------------|-----------------|-----------------------|
| ∞ | B30C-4000-569-PK | Pink | 101.60 | 30.48 | 1 | B30-R10000 |
| ∞ | B30C-4000-569-PL | Purple | 101.60 | 30.48 | 1 | B30-R10000-WT |
| ∞ | B30C-4000-569-RD | Red | 101.60 | 30.48 | 1 | B30-R10000-WT |
| ∞ | B30C-4000-569-SB | Sky Blue | 101.60 | 30.48 | 1 | B30-R10000 |
| ∞ | B30C-4000-569-TN | Tan | 101.60 | 30.48 | 1 | B30-R10000 |
| ∞ | B30C-4000-569-CL | Transparent | 101.60 | 30.48 | 1 | B30-R10000 |
| ∞ | B30C-4000-569-WT | White | 101.60 | 30.48 | 1 | B30-R10000 |
| ∞ | B30C-4000-569-YL | Yellow | 101.60 | 30.48 | 1 | B30-R10000 |

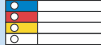

B-595 Pre-printed right-to-know chemical labels

For quickly creating NFPA and colour bar labels

- Allows the printer to produce 5 colour chemical labels in a single print pass
- Indoor/Outdoor grade material withstands exposure to moisture, chemicals and handling

| Diagram | Order Reference | Width A (mm) | Height B (mm) | Labels per Row | Labels per Roll | Recommended Ribbon | |
|---------|------------------|---|---------------|----------------|-----------------|--------------------|------------|
| ▲ | B30-244-595-DIAM |  | 57.00 | 57.15 | 1 | 365 | B30-R10000 |
| ▲ | B30-244-595-CB |  | 57.15 | 57.15 | 1 | 365 | B30-R10000 |
| ▲ | B30-244-595-HMIG |  | 57.15 | 57.15 | 1 | 365 | B30-R10000 |
| ▲ | B30-246-595-HMIG |  | 76.20 | 28.58 | 1 | 300 | B30-R10000 |
| ▲ | B30-246-595-NFR |  | 76.20 | 28.58 | 1 | 300 | B30-R10000 |
| ▲ | B30-244-595-NFPA |  | 76.20 | 57.15 | 1 | 365 | B30-R10000 |
| ▲ | B30-161-595-NFPA |  | 101.00 | 101.60 | 1 | 240 | B30-R10000 |
| ▲ | B30-245-595-CB |  | 101.60 | 57.15 | 1 | 240 | B30-R10000 |
| ▲ | B30-245-595-NFPA |  | 101.60 | 57.15 | 1 | 240 | B30-R10000 |
| ▲ | B30-263-595-NFPA |  | 152.40 | 101.60 | 1 | 170 | B30-R10000 |
| ▲ | B30-263-595-CB |  | 152.40 | 101.60 | 1 | 170 | B30-R10000 |

B-7569 Pre-printed CLP/GHS chemical labels

Print 2 colour CLP/GHS labels in one fast print pass

- Blank labels with pre-printed red diamonds allow printer to produce 2 colour CLP/GHS labels in one print pass
- 3 sizes of labels, each with 6 diamond layouts that match templates in Workstation software
- Indoor/outdoor vinyl material withstands exposure to moisture, chemicals and handling



| Diagram | Order Reference | | Width A (mm) | Height B (mm) | Labels per Row | Labels per Roll | Recommended Ribbon |
|---|--------------------|--|--------------|---------------|----------------|-----------------|--------------------|
|  | B30-260-7569-CLP1 | | 85.00 | 55.00 | 1 | 340 | B30-R10000 |
|  | B30-260-7569-CLP2 | | 85.00 | 55.00 | 1 | 340 | B30-R10000 |
|  | B30-260-7569-CLP3A | | 85.00 | 55.00 | 1 | 340 | B30-R10000 |
|  | B30-260-7569-CLP3B | | 85.00 | 55.00 | 1 | 340 | B30-R10000 |
|  | B30-260-7569-CLP4A | | 85.00 | 55.00 | 1 | 340 | B30-R10000 |
|  | B30-260-7569-CLP4B | | 85.00 | 55.00 | 1 | 340 | B30-R10000 |
|  | B30-261-7569-CLP1 | | 110.00 | 75.00 | 1 | 270 | B30-R10000 |
|  | B30-261-7569-CLP2 | | 110.00 | 75.00 | 1 | 270 | B30-R10000 |
|  | B30-261-7569-CLP3A | | 110.00 | 75.00 | 1 | 270 | B30-R10000 |
|  | B30-261-7569-CLP3B | | 110.00 | 75.00 | 1 | 270 | B30-R10000 |
|  | B30-261-7569-CLP4A | | 110.00 | 75.00 | 1 | 270 | B30-R10000 |
|  | B30-261-7569-CLP4B | | 110.00 | 75.00 | 1 | 270 | B30-R10000 |
|  | B30-262-7569-CLP1 | | 155.00 | 105.00 | 1 | 200 | B30-R10000 |
|  | B30-262-7569-CLP2 | | 155.00 | 105.00 | 1 | 200 | B30-R10000 |
|  | B30-262-7569-CLP3A | | 155.00 | 105.00 | 1 | 200 | B30-R10000 |
|  | B30-262-7569-CLP3B | | 155.00 | 105.00 | 1 | 200 | B30-R10000 |
|  | B30-262-7569-CLP4A | | 155.00 | 105.00 | 1 | 200 | B30-R10000 |
|  | B30-262-7569-CLP4B | | 155.00 | 105.00 | 1 | 200 | B30-R10000 |
|  | B30-18-7569-CLP4C | | 76.20 | 25.40 | 1 | 1000 | B30-R10000 |

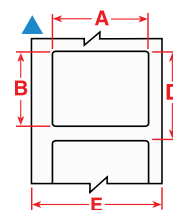

Facility and safety applications:

5S Labels, pipe markers, safety & warning labels, equipment & panel labels, arc flash & chemical labels and more!



LabelMark Upgrade Suite

Easily recreate all LabelMark functionalities with upgraded features in Brady Workstation.

For more information about the Brady Workstation Software Suites, see page 49.



B-854 and B-855 ToughWash washdown resistant labels

Withstands pressures of high heat, harsh chemicals and numerous washdown cycles

- Ideal for use in the Food & Beverage industry
- Legible and long-lasting for even the toughest washdown cycles
- B-854 offers metal detectable layer to detect foreign debris in food stream

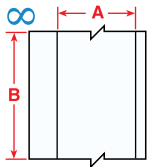
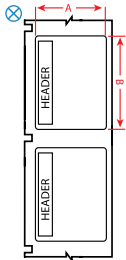

| Diagram | Order Reference | | Label Width A (mm) | Label Height B (mm) | Vertical Repeat D (mm) | Labels per Roll | Printer Ribbon Series |
|--|------------------|--|--------------------|---------------------|------------------------|-----------------|-----------------------|
| B-854: Metal Detectable Polyester | | | | | | | |
| ∞ | B30C-4000-854-YL | | 101.60 | - | - | 1 | B30-R6000HF |
| ∞ | B30C-4000-854-WT | | 101.60 | - | - | 1 | B30-R6000HF |
| ⊗ | B30-25-854-WARN | | 101.60 | 152.40 | 158.75 | 100 | B30-R6000HF |
| ⊗ | B30-25-854-DANG | | 101.60 | 152.40 | 158.75 | 100 | B30-R6000HF |
| ⊗ | B30-25-854-CAUT | | 101.60 | 152.40 | 158.75 | 100 | B30-R6000HF |
| B-855: Polyester | | | | | | | |
| ∞ | B30C-1125-855-YL | | 28.58 | - | - | 1 | B30-R6000HF |
| ∞ | B30C-1125-855-WT | | 28.58 | - | - | 1 | B30-R6000HF |
| ∞ | B30C-2250-855-YL | | 57.15 | - | - | 1 | B30-R6000HF |
| ∞ | B30C-2250-855-WT | | 57.15 | - | - | 1 | B30-R6000HF |
| ∞ | B30C-4000-855-YL | | 101.60 | - | - | 1 | B30-R6000HF |
| ∞ | B30C-4000-855-WT | | 101.60 | - | - | 1 | B30-R6000HF |
| ⊗ | B30-25-855-WARN | | 101.60 | 152.40 | 158.75 | 100 | B30-R6000HF |
| ⊗ | B30-25-855-DANG | | 101.60 | 152.40 | 158.75 | 100 | B30-R6000HF |
| ⊗ | B30-25-855-CAUT | | 101.60 | 152.40 | 158.75 | 100 | B30-R6000HF |



B-595 and B-7569 Pre-cut Blank labels

For general purpose, peel-off-and-apply identification

- Ideal for a wide range of labelling applications
- Includes two sizes that are pre-cut and pre-sized to fit heavy-duty rigid tags
- Indoor/Outdoor grade material

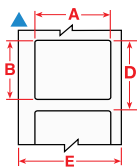

| Diagram | Order Reference | Colour | Label Width A (mm) | Label Height B (mm) | Vertical Repeat D (mm) | Labels per Roll | Printer Ribbon Series |
|----------------------|--------------------|--------|--------------------|---------------------|------------------------|-----------------|-----------------------|
| B-595: Vinyl | | | | | | | |
| ▲ | B30-242-595-BLNKWT | White | 28.58 | 72.39 | 82.55 | 300 | B30-R10000 |
| ▲ | B30-241-595-BLNKWT | White | 76.20 | 57.15 | 82.55 | 300 | B30-R10000 |
| ▲ | B30-241-595-BLNKYL | Yellow | 76.20 | 57.15 | 82.55 | 300 | B30-R10000 |
| ▲ | B30-219-595-BLNKWT | White | 97.79 | 57.15 | 107.95 | 250 | B30-R10000 |
| ▲ | B30-25-595-BLNKWT | White | 152.40 | 101.60 | 158.75 | 175 | B30-R10000 |
| ▲ | B30-25-595-BLNKYL | Yellow | 152.40 | 101.60 | 158.75 | 175 | B30-R10000 |
| B-7569: Vinyl | | | | | | | |
| ▲ | B30-242-7569-WT | White | 28.58 | 72.00 | 82.55 | 300 | B30-R10000 |
| ▲ | B30-241-7569-WT | White | 57.00 | 75.00 | 82.55 | 300 | B30-R10000 |
| ▲ | B30-219-7569-WT | White | 57.00 | 98.00 | 107.95 | 250 | B30-R10000 |
| ▲ | B30-241-7569-YL | Yellow | 57.00 | 75.00 | 82.55 | 300 | B30-R10000 |
| ▲ | B30-25-7569-WT | White | 101.00 | 152.00 | 158.75 | 175 | B30-R10000 |
| ▲ | B30-25-7569-YL | Yellow | 101.00 | 152.00 | 158.75 | 175 | B30-R10000 |

B-551 Non-adhesive continuous tag stock

For safety, lockout and general purpose hanging tags

- Non-adhesive, polyester stock
- Hole punch available separately. Order reference: 020591
- Optional snap-in grommets available. Order Reference: 020596

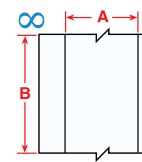

| Diagram | Order Reference | Colour | Label Width A (mm) | Label Height B (mm) | Label Length B (m) | Vertical Repeat D (mm) | Labels per Roll | Printer Ribbon Series |
|------------------|------------------|--------|--------------------|---------------------|--------------------|------------------------|-----------------|-----------------------|
| B-551: Polyester | | | | | | | | |
| | B30-255-551-WT | White | 82.55 | 146.05 | - | 158.75 | 100 | B30-R10000 |
| | B30C-2500-551-WT | White | 63.50 | - | 15.24 | - | 1 | B30-R10000 |
| | B30C-3250-551-WT | White | 82.55 | - | 15.24 | - | 1 | B30-R10000 |
| | B30C-4250-551-WT | White | 107.95 | - | 15.24 | - | 1 | B30-R10000 |

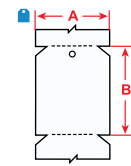

B-584 Retro reflective tape

For Highly reflective identification that shines back brightly when struck by light

- Ideal for labelling outdoor utility poles and pedestals, jobsite equipment and roof-top equipment
- Recommended low light or inclement weather conditions

| Diagram | Order Reference | Colour | Label Width A (mm) | Label Length B (m) | Labels per Roll | Printer Ribbon Series |
|------------------------|------------------|--------|--------------------|--------------------|-----------------|-----------------------|
| B-584: Reflective Tape | | | | | | |
| | B30C-1125-584-OR | Orange | 28.58 | 15.24 | 1 | B30-R10000 |
| | B30C-1125-584-SL | Silver | 28.58 | 15.24 | 1 | B30-R10000 |
| | B30C-1125-584-YL | Yellow | 28.58 | 15.24 | 1 | B30-R10000 |
| | B30C-2250-584-OR | Orange | 57.15 | 15.24 | 1 | B30-R10000 |
| | B30C-2250-584-SL | Silver | 57.15 | 15.24 | 1 | B30-R10000 |
| | B30C-2250-584-YL | Yellow | 57.15 | 15.24 | 1 | B30-R10000 |
| | B30C-4000-584-OR | Orange | 101.60 | 15.24 | 1 | B30-R10000 |
| | B30C-4000-584-SL | Silver | 101.60 | 15.24 | 1 | B30-R10000 |
| | B30C-4000-584-YL | Yellow | 101.60 | 15.24 | 1 | B30-R10000 |

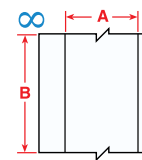

B-526 BradyGlo High-intensity photoluminescent tape

For glow-in-the dark identification - Up to 10 hours

- Designed for directional and evacuation marking
- Ideal for marking emergency utility shut-offs, fire extinguishers, alarm pulls and vital equipment controls

| Diagram | Order Reference | Colour | Label Width A (mm) | Label Length B (m) | Labels per Roll | Printer Ribbon Series |
|---------------------------------|-----------------|------------------------|--------------------|--------------------|-----------------|-----------------------|
| B-526: Phosphorescent Polyester | | | | | | |
| | B30C-1125-526 | Photoluminescent Green | 28.58 | 15.24 | 1 | B30-R10000 |
| | B30C-2250-526 | Photoluminescent Green | 57.15 | 15.24 | 1 | B30-R10000 |
| | B30C-4000-526 | Photoluminescent Green | 101.60 | 15.24 | 1 | B30-R10000 |

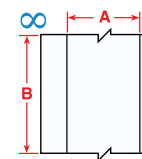

B-787 Polyvinyl fluoride tape

Ideal for applications where self-extinguishing properties are required

Polyvinylfluoride (B-787) tape is ideal for label applications where self-extinguishing properties are required. Glossy white topcoated material with permanent acrylic adhesive Meets the colour requirements of FED-STD-595C Colour 17875 White and complies with the requirements of Boeing BMS 10-26 Type I, Grade A

| Diagram | Order Reference | Colour | Label Width A (mm) | Label Length B (m) | Labels per Roll | Printer Ribbon Series |
|--------------------------|-----------------|--------|--------------------|--------------------|-----------------|-----------------------|
| B-787: Polyvinylfluoride | | | | | | |
| | B30C-4000-787 | White | 101.00 | 18.29 | 1 | B30-R6000HF |

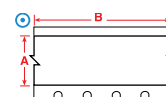



B-581 Repositionable vinyl

For 5S and lean applications

- Aggressive adhesive stays in place but removes cleanly without leaving adhesive residue
- Ideal for temporary, removable and repositionable labels, like 5S and lean inventory labels
- Service temp: -40 °C to 82 °C
- Application temp: 10 °C to 82 °C

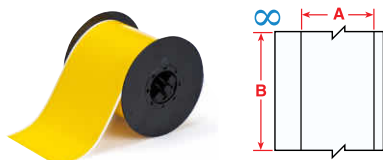

| Diagram | Order Reference | Colour | Label Width A (mm) | Label Length B (m) | Labels per Roll | Printer Ribbon Series |
|--------------|------------------|--------|--------------------|--------------------|-----------------|-----------------------|
| B-581: Vinyl | | | | | | |
| ∞ | B30C-500-581-WT | White | 12.70 | 30.48 | 1 | B30-R10000 |
| ∞ | B30C-500-581-YL | Yellow | 12.70 | 30.48 | 1 | B30-R10000 |
| ∞ | B30C-1125-581-WT | White | 28.58 | 30.48 | 1 | B30-R10000 |
| ∞ | B30C-1125-581-YL | Yellow | 28.58 | 30.48 | 1 | B30-R10000 |
| ∞ | B30C-2250-581-WT | White | 57.15 | 30.48 | 1 | B30-R10000 |
| ∞ | B30C-2250-581-YL | Yellow | 57.15 | 30.48 | 1 | B30-R10000 |
| ∞ | B30C-4000-581-WT | White | 101.60 | 30.48 | 1 | B30-R10000 |
| ∞ | B30C-4000-581-YL | Yellow | 101.60 | 30.48 | 1 | B30-R10000 |



B-509 Printable magnetic supply

Easiest and quickest material for removing and repositioning

- Non-adhesive magnetic material that can be printed on directly
- Ideal for reusable and repositionable identification applications

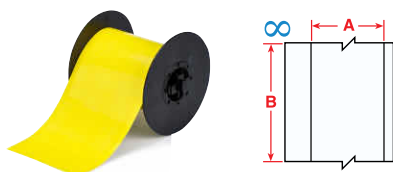

| Diagram | Order Reference | Colour | Label Width A (mm) | Label Length B (m) | Labels per Roll | Printer Ribbon Series |
|---------------------------|------------------|--------|--------------------|--------------------|-----------------|-----------------------|
| B-509: Magnetic Polyester | | | | | | |
| ∞ | B30C-2500-509-WT | White | 63.50 | 7.62 | 1 | B30-R10000 |
| ∞ | B30C-2500-509-YL | Yellow | 63.50 | 7.62 | 1 | B30-R10000 |
| ∞ | B30C-4250-509-WT | White | 107.95 | 7.62 | 1 | B30-R10000 |
| ∞ | B30C-4250-509-YL | Yellow | 107.95 | 7.62 | 1 | B30-R10000 |



Toughstripe floor marking tape

Removable area marking tape

ToughStripe is the ideal floor marking tape in a lean environment where the regular application and replacement of floor marking is crucial.



- Superior durability
- Easy application
- High visibility
- Die-Cut shapes
- Painless Removal

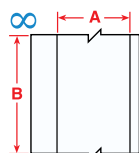

| Diagram | Order Reference | Colour | Label Width A (mm) | Label Length B (m) | Labels per Roll | Printer Ribbon Series |
|--|--------------------|--------|--------------------|--------------------|-----------------|-----------------------|
| B-483A/B-634: Polyester with Polyester Overlaminat | | | | | | |
| ∞ | B30C-1125-483BK-KT | Black | 29.00 | 30.40 | 1 | B30-R4400 |
| ∞ | B30C-1125-483BL-KT | Blue | 29.00 | 30.40 | 1 | B30-R4400 |
| ∞ | B30C-1125-483GN-KT | Green | 29.00 | 30.40 | 1 | B30-R4400 |
| ∞ | B30C-1125-483OR-KT | Orange | 29.00 | 30.40 | 1 | B30-R6000HF |
| ∞ | B30C-1125-483RD-KT | Red | 29.00 | 30.40 | 1 | B30-R4400 |
| ∞ | B30C-1125-483WT-KT | White | 29.00 | 30.40 | 1 | B30-R6000HF |
| ∞ | B30C-1125-483YL-KT | Yellow | 29.00 | 30.40 | 1 | B30-R6000HF |
| ∞ | B30C-2250-483BK-KT | Black | 57.00 | 30.40 | 1 | B30-R4400 |
| ∞ | B30C-2250-483BL-KT | Blue | 57.00 | 30.40 | 1 | B30-R4400 |
| ∞ | B30C-2250-483GN-KT | Green | 57.00 | 30.40 | 1 | B30-R4400 |
| ∞ | B30C-2250-483OR-KT | Orange | 57.00 | 30.40 | 1 | B30-R6000HF |
| ∞ | B30C-2250-483RD-KT | Red | 57.00 | 30.40 | 1 | B30-R4400 |
| ∞ | B30C-2250-483WT-KT | White | 57.00 | 30.40 | 1 | B30-R6000HF |
| ∞ | B30C-2250-483YL-KT | Yellow | 57.00 | 30.40 | 1 | B30-R6000HF |
| ∞ | B30C-3000-483WT-KT | White | 75.00 | 30.40 | 1 | B30-R6000HF |
| ∞ | B30C-3000-483YL-KT | Yellow | 75.00 | 30.40 | 1 | B30-R6000HF |
| ∞ | B30C-4000-483BK-KT | Black | 101.00 | 30.40 | 1 | B30-R4400 |
| ∞ | B30C-4000-483BL-KT | Blue | 101.00 | 30.40 | 1 | B30-R4400 |
| ∞ | B30C-4000-483GN-KT | Green | 101.00 | 30.40 | 1 | B30-R4400 |
| ∞ | B30C-4000-483OR-KT | Orange | 101.00 | 30.40 | 1 | B30-R6000HF |
| ∞ | B30C-4000-483RD-KT | Red | 101.00 | 30.40 | 1 | B30-R4400 |
| ∞ | B30C-4000-483WT-KT | White | 101.00 | 30.40 | 1 | B30-R6000HF |
| ∞ | B30C-4000-483YL-KT | Yellow | 101.00 | 30.40 | 1 | B30-R6000HF |

B-7569 Indoor/Outdoor vinyl

General purpose industrial vinyl for indoor/outdoor usage

- High gloss, durable and flexible identification material
- Adheres to difficult low surface energy materials
- Can handle up to 75°C, which meets industry maintenance temperatures
- Low-shrink vinyl

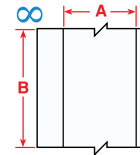

| Diagram | Order Reference | Colour | Label Width A (mm) | Label Length B (m) | Labels per Roll | Printer Ribbon Series |
|---------------|-------------------|--------|--------------------|--------------------|-----------------|-----------------------|
| B-7569: Vinyl | | | | | | |
| ∞ | B30C-500-7569-BK | Black | 12.70 | 30.00 | 1 | B30-R10000-WT |
| ∞ | B30C-500-7569-BL | Blue | 12.70 | 30.00 | 1 | B30-R10000-WT |
| ∞ | B30C-500-7569-GN | Green | 12.70 | 30.00 | 1 | B30-R10000-WT |
| ∞ | B30C-500-7569-OR | Orange | 12.70 | 30.00 | 1 | B30-R10000 |
| ∞ | B30C-500-7569-RD | Red | 12.70 | 30.00 | 1 | B30-R10000-WT |
| ∞ | B30C-500-7569-WT | White | 12.70 | 30.00 | 1 | B30-R10000 |
| ∞ | B30C-500-7569-YL | Yellow | 12.70 | 30.00 | 1 | B30-R10000 |
| ∞ | B30C-1125-7569-BK | Black | 29.00 | 30.00 | 1 | B30-R10000-WT |
| ∞ | B30C-1125-7569-BL | Blue | 29.00 | 30.00 | 1 | B30-R10000-WT |
| ∞ | B30C-1125-7569-GN | Green | 29.00 | 30.00 | 1 | B30-R10000-WT |
| ∞ | B30C-1125-7569-OR | Orange | 29.00 | 30.00 | 1 | B30-R10000 |
| ∞ | B30C-1125-7569-RD | Red | 29.00 | 30.00 | 1 | B30-R10000-WT |
| ∞ | B30C-1125-7569-WT | White | 29.00 | 30.00 | 1 | B30-R10000 |
| ∞ | B30C-1125-7569-YL | Yellow | 29.00 | 30.00 | 1 | B30-R10000 |
| ∞ | B30C-2250-7569-BK | Black | 57.00 | 30.00 | 1 | B30-R10000-WT |
| ∞ | B30C-2250-7569-BL | Blue | 57.00 | 30.00 | 1 | B30-R10000-WT |
| ∞ | B30C-2250-7569-GN | Green | 57.00 | 30.00 | 1 | B30-R10000-WT |
| ∞ | B30C-2250-7569-OR | Orange | 57.00 | 30.00 | 1 | B30-R10000 |
| ∞ | B30C-2250-7569-RD | Red | 57.00 | 30.00 | 1 | B30-R10000-WT |
| ∞ | B30C-2250-7569-WT | White | 57.00 | 30.00 | 1 | B30-R10000 |
| ∞ | B30C-2250-7569-YL | Yellow | 57.00 | 30.00 | 1 | B30-R10000 |
| ∞ | B30C-3000-7569-WT | White | 75.00 | 30.00 | 1 | B30-R10000 |
| ∞ | B30C-3000-7569-YL | Yellow | 75.00 | 30.00 | 1 | B30-R10000 |
| ∞ | B30C-4000-7569-BK | Black | 101.00 | 30.00 | 1 | B30-R10000-WT |
| ∞ | B30C-4000-7569-BL | Blue | 101.00 | 30.00 | 1 | B30-R10000-WT |
| ∞ | B30C-4000-7569-GN | Green | 101.00 | 30.00 | 1 | B30-R10000-WT |
| ∞ | B30C-4000-7569-OR | Orange | 101.00 | 30.00 | 1 | B30-R10000 |
| ∞ | B30C-4000-7569-RD | Red | 101.00 | 30.00 | 1 | B30-R10000-WT |
| ∞ | B30C-4000-7569-WT | White | 101.00 | 30.00 | 1 | B30-R10000 |
| ∞ | B30C-4000-7569-YL | Yellow | 101.00 | 30.00 | 1 | B30-R10000 |

B-549 Cold temperature application material

For identification in temperature as cold as -40°C

- Special adhesive permanently adheres to extremely cold surfaces
- Ideal for cold storage warehouses, fridges, freezers and short-term outdoor use in winter
- Service temp: -40 °C to 100 °C
- Application temp: -23 °C to 100 °C

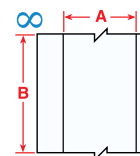

| Diagram | Order Reference | Colour | Label Width A (mm) | Label Length B (m) | Labels per Roll | Printer Ribbon Series |
|------------------|------------------|--------|--------------------|--------------------|-----------------|-----------------------|
| B-549: Polyester | | | | | | |
| ∞ | B30C-1125-549-WT | White | 28.58 | 30.48 | 1 | B30-R10000 |
| ∞ | B30C-1125-549-YL | Yellow | 28.58 | 30.48 | 1 | B30-R10000 |
| ∞ | B30C-2250-549-WT | White | 57.15 | 30.48 | 1 | B30-R10000 |
| ∞ | B30C-2250-549-YL | Yellow | 57.15 | 30.48 | 1 | B30-R10000 |
| ∞ | B30C-4000-549-WT | White | 101.60 | 30.48 | 1 | B30-R10000 |
| ∞ | B30C-4000-549-YL | Yellow | 101.60 | 30.48 | 1 | B30-R10000 |

B-593 Raised profile labels - Push button style

Lower cost than engraved legend plates

- High gloss, polyester label with thick raised profile and ultra-aggressive adhesive (total thickness = 0.65 mm)
- High performance, low cost substitute to engraved plates
- 10 year outdoor durability rating
- On-demand labelling: labels print out in less than 4 seconds
- 5 push button sizes (including keyed with 22.50 and 30.50 mm hole diam and non-keyed with 22.50 mm hole diam)

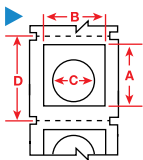
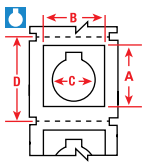

| Diagram | Order Reference | Colour | Label Width A (mm) | Label Height B (mm) | Vertical Repeat D (mm) | Labels per Roll | Printer Ribbon Series |
|------------------|-------------------|--------|--------------------|---------------------|------------------------|-----------------|-----------------------|
| B-593: Polyester | | | | | | | |
| | B30EP-167-593-BK | Black | 30.48 | 38.10 | 44.45 | 200 | B30 Monocolour Series |
| | B30EP-167-593-GN | Green | 30.48 | 38.10 | 44.45 | 200 | B30 Monocolour Series |
| | B30EP-167-593-RD | Red | 30.48 | 38.10 | 44.45 | 200 | B30 Monocolour Series |
| | B30EP-167-593-WT | White | 30.48 | 38.10 | 44.45 | 200 | B30 Monocolour Series |
| | B30EP-167-593-YL | Yellow | 30.48 | 38.10 | 44.45 | 200 | B30 Monocolour Series |
| | B30EP-167U-593-BK | Black | 30.48 | 38.10 | 44.45 | 200 | B30 Monocolour Series |
| | B30EP-167U-593-GN | Green | 30.48 | 38.10 | 44.45 | 200 | B30 Monocolour Series |
| | B30EP-167U-593-RD | Red | 30.48 | 38.10 | 44.45 | 200 | B30 Monocolour Series |
| | B30EP-167U-593-WT | White | 30.48 | 38.10 | 44.45 | 200 | B30 Monocolour Series |
| | B30EP-167U-593-YL | Yellow | 30.48 | 38.10 | 44.45 | 200 | B30 Monocolour Series |
| | B30EP-168-593-BK | Black | 30.48 | 48.26 | 53.98 | 180 | B30 Monocolour Series |
| | B30EP-168-593-GN | Green | 30.48 | 48.26 | 53.98 | 180 | B30 Monocolour Series |
| | B30EP-168-593-RD | Red | 30.48 | 48.26 | 53.98 | 180 | B30 Monocolour Series |
| | B30EP-168-593-WT | White | 30.48 | 48.26 | 53.98 | 180 | B30 Monocolour Series |
| | B30EP-168-593-YL | Yellow | 30.48 | 48.26 | 53.98 | 180 | B30 Monocolour Series |
| | B30EP-169-593-BK | Black | 45.72 | 45.72 | 50.80 | 190 | B30 Monocolour Series |
| | B30EP-169-593-GN | Green | 45.72 | 45.72 | 50.80 | 190 | B30 Monocolour Series |
| | B30EP-169-593-RD | Red | 45.72 | 45.72 | 50.80 | 190 | B30 Monocolour Series |
| | B30EP-169-593-WT | White | 45.72 | 45.72 | 50.80 | 190 | B30 Monocolour Series |
| | B30EP-169-593-YL | Yellow | 45.72 | 45.72 | 50.80 | 190 | B30 Monocolour Series |
| | B30EP-170-593-BK | Black | 60.96 | 60.96 | 66.68 | 145 | B30 Monocolour Series |
| | B30EP-170-593-GN | Green | 60.96 | 60.96 | 66.68 | 145 | B30 Monocolour Series |
| | B30EP-170-593-RD | Red | 60.96 | 60.96 | 66.68 | 145 | B30 Monocolour Series |
| | B30EP-170-593-WT | White | 60.96 | 60.96 | 66.68 | 145 | B30 Monocolour Series |
| | B30EP-170-593-YL | Yellow | 60.96 | 60.96 | 66.68 | 145 | B30 Monocolour Series |

B-593 Raised profile labels

Lower cost than engraved legend plates

- High gloss, polyester label with thick raised profile and ultra-aggressive adhesive (0.65 mm)
- Ideal for inside-panel backer board labels and front-of-enclosure labelling
- On-demand labelling: labels print out in less than 4 seconds
- No need to abbreviate your text to avoid per character engraving charges
- 10-year outdoor durability rating
- 6 colours, 7 rectangular sizes

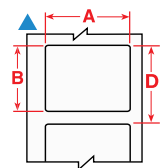

| Diagram | Order Reference | Colour | Label Width A (mm) | Label Height B (mm) | Vertical Repeat D (mm) | Labels per Roll | Printer Ribbon Series |
|------------------|------------------|--------|--------------------|---------------------|------------------------|-----------------|-----------------------|
| B-593: Polyester | | | | | | | |
| | B30EP-171-593-BK | Black | 27.00 | 12.45 | 19.05 | 500 | B30 Monocolour Series |
| | B30EP-171-593-GN | Green | 27.00 | 12.45 | 19.05 | 500 | B30 Monocolour Series |
| | B30EP-171-593-RD | Red | 27.00 | 12.45 | 19.05 | 500 | B30 Monocolour Series |
| | B30EP-171-593-SL | Silver | 27.00 | 12.45 | 19.05 | 500 | B30 Monocolour Series |
| | B30EP-171-593-WT | White | 27.00 | 12.45 | 19.05 | 500 | B30 Monocolour Series |
| | B30EP-171-593-YL | Yellow | 27.00 | 12.45 | 19.05 | 500 | B30 Monocolour Series |
| | B30EP-172-593-BK | Black | 44.99 | 15.00 | 21.59 | 450 | B30 Monocolour Series |
| | B30EP-172-593-GN | Green | 44.99 | 15.00 | 21.59 | 450 | B30 Monocolour Series |
| | B30EP-172-593-RD | Red | 44.99 | 15.00 | 21.59 | 450 | B30 Monocolour Series |
| | B30EP-172-593-SL | Silver | 44.99 | 15.00 | 21.59 | 450 | B30 Monocolour Series |
| | B30EP-172-593-WT | White | 44.99 | 15.00 | 21.59 | 450 | B30 Monocolour Series |

>>

B-593 Raised profile labels (Continued)

Lower cost than engraved legend plates

| Diagram | Order Reference | Colour | Label Width A (mm) | Label Height B (mm) | Vertical Repeat D (mm) | Labels per Roll | Printer Ribbon Series |
|------------------|------------------|--------|--------------------|---------------------|------------------------|-----------------|-----------------------|
| B-593: Polyester | | | | | | | |
| ▲ | B30EP-171-593-BK | Black | 27.00 | 12.45 | 19.05 | 500 | B30 Monocolour Series |
| ▲ | B30EP-171-593-GN | Green | 27.00 | 12.45 | 19.05 | 500 | B30 Monocolour Series |
| ▲ | B30EP-171-593-RD | Red | 27.00 | 12.45 | 19.05 | 500 | B30 Monocolour Series |
| ▲ | B30EP-171-593-SL | Silver | 27.00 | 12.45 | 19.05 | 500 | B30 Monocolour Series |
| ▲ | B30EP-171-593-WT | White | 27.00 | 12.45 | 19.05 | 500 | B30 Monocolour Series |
| ▲ | B30EP-171-593-YL | Yellow | 27.00 | 12.45 | 19.05 | 500 | B30 Monocolour Series |
| ▲ | B30EP-172-593-BK | Black | 44.99 | 15.00 | 21.59 | 450 | B30 Monocolour Series |
| ▲ | B30EP-172-593-GN | Green | 44.99 | 15.00 | 21.59 | 450 | B30 Monocolour Series |
| ▲ | B30EP-172-593-RD | Red | 44.99 | 15.00 | 21.59 | 450 | B30 Monocolour Series |
| ▲ | B30EP-172-593-SL | Silver | 44.99 | 15.00 | 21.59 | 450 | B30 Monocolour Series |
| ▲ | B30EP-172-593-WT | White | 44.99 | 15.00 | 21.59 | 450 | B30 Monocolour Series |
| ▲ | B30EP-172-593-YL | Yellow | 44.99 | 15.00 | 21.59 | 450 | B30 Monocolour Series |
| ▲ | B30EP-173-593-BK | Black | 50.80 | 25.40 | 31.75 | 300 | B30 Monocolour Series |
| ▲ | B30EP-173-593-GN | Green | 50.80 | 25.40 | 31.75 | 300 | B30 Monocolour Series |
| ▲ | B30EP-173-593-RD | Red | 50.80 | 25.40 | 31.75 | 300 | B30 Monocolour Series |
| ▲ | B30EP-173-593-SL | Silver | 50.80 | 25.40 | 31.75 | 300 | B30 Monocolour Series |
| ▲ | B30EP-173-593-WT | White | 50.80 | 25.40 | 31.75 | 300 | B30 Monocolour Series |
| ▲ | B30EP-173-593-YL | Yellow | 50.80 | 25.40 | 31.75 | 300 | B30 Monocolour Series |
| ▲ | B30EP-174-593-BK | Black | 101.60 | 25.40 | 28.58 | 300 | B30 Monocolour Series |
| ▲ | B30EP-174-593-GN | Green | 101.60 | 25.40 | 28.58 | 300 | B30 Monocolour Series |
| ▲ | B30EP-174-593-RD | Red | 101.60 | 25.40 | 28.58 | 300 | B30 Monocolour Series |
| ▲ | B30EP-174-593-SL | Silver | 101.60 | 25.40 | 28.58 | 300 | B30 Monocolour Series |
| ▲ | B30EP-174-593-WT | White | 101.60 | 25.40 | 28.58 | 300 | B30 Monocolour Series |
| ▲ | B30EP-174-593-YL | Yellow | 101.60 | 25.40 | 28.58 | 300 | B30 Monocolour Series |
| ▲ | B30EP-175-593-BK | Black | 76.20 | 19.05 | 25.40 | 375 | B30 Monocolour Series |
| ▲ | B30EP-175-593-GN | Green | 76.20 | 19.05 | 25.40 | 375 | B30 Monocolour Series |
| ▲ | B30EP-175-593-WT | White | 76.20 | 19.05 | 25.40 | 375 | B30 Monocolour Series |
| ▲ | B30EP-175-593-YL | Yellow | 76.20 | 19.05 | 25.40 | 375 | B30 Monocolour Series |
| ▲ | B30EP-176-593-BK | Black | 76.20 | 25.40 | 31.75 | 300 | B30 Monocolour Series |
| ▲ | B30EP-176-593-GN | Green | 76.20 | 25.40 | 31.75 | 300 | B30 Monocolour Series |
| ▲ | B30EP-176-593-WT | White | 76.20 | 25.40 | 31.75 | 300 | B30 Monocolour Series |
| ▲ | B30EP-176-593-YL | Yellow | 76.20 | 25.40 | 31.75 | 300 | B30 Monocolour Series |
| ▲ | B30EP-177-593-BK | Black | 76.20 | 63.50 | 69.85 | 125 | B30 Monocolour Series |
| ▲ | B30EP-177-593-GN | Green | 76.20 | 63.50 | 69.85 | 125 | B30 Monocolour Series |
| ▲ | B30EP-177-593-WT | White | 76.20 | 63.50 | 69.85 | 125 | B30 Monocolour Series |
| ▲ | B30EP-177-593-YL | Yellow | 76.20 | 63.50 | 69.85 | 125 | B30 Monocolour Series |

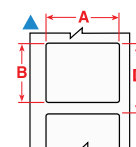

Inside-panel component labels

For automation & electrical panels and enclosures

- Various sizes in several durable material types
- Ideal for marking backer board, DIN rail, relays, PLCs, switches, solenoids, drive motors and other components
- All recommended materials are flexible and have high-tack adhesives for adhesion to wide variety of surfaces and components

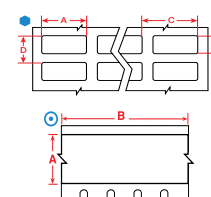
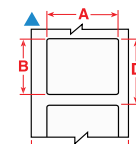

| Diagram | Order Reference | Colour | Label Width A (mm) | Label Height B (mm) | Label Length B (m) | Vertical Repeat D (mm) | Labels per Roll | Printer Ribbon Series |
|-------------------|-----------------|--------|--------------------|---------------------|--------------------|------------------------|-----------------|-----------------------|
| B-422: Polyester | | | | | | | | |
| ⊙ | B33C-375-422 | White | 9.53 | – | 25.91 m | – | 1 | B30-R6000HF |
| B-483A: Polyester | | | | | | | | |
| ⬢ | B33-149-483 | White | 12.70 | 12.70 | – | 15.24 | 5000 | B30 Monocolour Series |
| ⬢ | B33-5-483 | White | 25.40 | 12.70 | – | 15.24 | 5000 | B30 Monocolour Series |
| ▲ | B33-17-483 | White | 50.80 | 25.40 | – | 28.58 | 1500 | B30 Monocolour Series |
| ▲ | B33-7-483 | White | 69.85 | 31.75 | – | 34.93 | 1000 | B30 Monocolour Series |
| ▲ | B33-19-483 | White | 76.20 | 50.80 | – | 53.98 | 500 | B30 Monocolour Series |
| ▲ | B33-18-483 | White | 76.20 | 25.40 | – | 28.58 | 1500 | B30 Monocolour Series |
| ▲ | B33-55-483 | White | 101.60 | 50.80 | – | 53.98 | 750 | B30 Monocolour Series |

>>

Inside-panel component labels (Continued)

For automation & electrical panels and enclosures

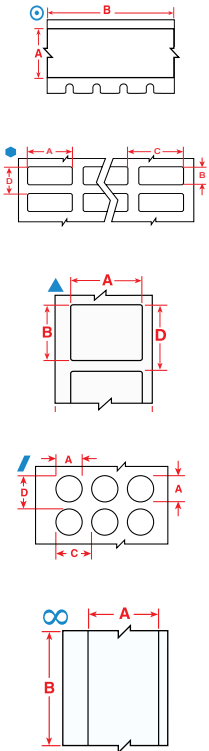

| Diagram | Order Reference | Colour | Label Width A (mm) | Label Height B (mm) | Label Length B (m) | Vertical Repeat D (mm) | Labels per Roll | Printer Ribbon Series |
|---------------------------|------------------|--------|-----------------------|------------------------|-----------------------|---------------------------|--------------------|--------------------------|
| B-484A: Polyester | | | | | | | | |
| ▲ | B33-125-484 | White | 22.86 | 12.70 | | 15.24 | 1500 | B30 Monocolour Series |
| ● | B33-5-484 | White | 25.40 | 12.70 | | 15.24 | 5000 | B30 Monocolour Series |
| ▲ | B33-136-484 | White | 38.10 | 19.05 | | 22.23 | 1500 | B30 Monocolour Series |
| ▲ | B33-17-484 | White | 50.80 | 25.40 | | 28.58 | 1500 | B30 Monocolour Series |
| ▲ | B33-18-484 | White | 76.20 | 25.40 | | 28.58 | 1500 | B30 Monocolour Series |
| ▲ | B33-19-484 | White | 76.20 | 50.80 | | 53.98 | 500 | B30 Monocolour Series |
| ▲ | B33-55-484 | White | 101.60 | 50.80 | | 53.98 | 750 | B30 Monocolour Series |
| ▲ | B33-161-484 | White | 101.60 | 101.60 | | 104.78 | 350 | B30 Monocolour Series |
| B-498: Vinyl Cloth | | | | | | | | |
| ● | B33-90-498 | White | 6.35 | 36.50 | | 39.70 | 2500 | B30 Monocolour Series |
| ● | B33-87-498 | White | 12.70 | 36.50 | | 39.70 | 2500 | B30 Monocolour Series |
| ● | B33-68-498 | White | 12.70 | 19.05 | | 21.59 | 5000 | B30 Monocolour Series |
| ● | B33-1-498 | White | 19.05 | 6.35 | | 8.89 | 5000 | B30 Monocolour Series |
| ▲ | B33-254-498 | White | 19.05 | 19.05 | | 21.59 | 1000 | B30 Monocolour Series |
| ● | B33-95-498 | White | 20.32 | 36.50 | | 39.70 | 2300 | B30 Monocolour Series |
| ● | B33-88-498 | White | 25.40 | 19.05 | | 22.23 | 2500 | B30 Monocolour Series |
| ● | B33-5-498 | White | 25.40 | 12.70 | | 15.24 | 5000 | B30 Monocolour Series |
| ● | B33-89-498 | White | 25.40 | 36.50 | | 39.70 | 2300 | B30 Monocolour Series |
| ● | B33-325-498 | White | 25.40 | 63.50 | | 66.68 | 700 | B30 Monocolour Series |
| ● | B33-326-498 | White | 25.40 | 101.60 | | 104.78 | 450 | B30 Monocolour Series |
| ● | B33-327-498 | White | 38.10 | 101.60 | | 104.78 | 450 | B30 Monocolour Series |
| ● | B33-328-498 | White | 38.10 | 152.40 | | 155.58 | 300 | B30 Monocolour Series |
| B-499: Nylon Cloth | | | | | | | | |
| ● | B33-68-499 | White | 12.70 | 19.05 | | 21.59 | 1500 | B30 Monocolour Series |
| ● | B33-165-499 | White | 20.32 | 36.50 | | 39.70 | 2500 | B30 Monocolour Series |
| ▲ | B33-125-499 | White | 22.86 | 12.70 | | 15.24 | 1500 | B30 Monocolour Series |
| ● | B33-152-499 | White | 25.40 | 9.53 | | 12.07 | 1500 | B30 Monocolour Series |
| ▲ | B33-136-499 | White | 38.10 | 19.05 | | 22.23 | 1500 | B30 Monocolour Series |
| ▲ | B33-151-499 | White | 50.80 | 6.35 | | 8.89 | 1500 | B30 Monocolour Series |
| / | B33-143-499 | White | – | – | | 12.70 | 1500 | B30 Monocolour Series |
| / | B33-144-499 | White | – | – | | 15.88 | 1500 | B30 Monocolour Series |
| / | B33-602-499 | White | – | – | | 16.50 | 3000 | B30-R6000HF |
| / | B33-603-499 | White | – | – | | 15.70 | 3000 | B30-R6000HF |
| / | B33-602-499YL | Yellow | – | – | | 16.50 | 3000 | B30-R6000HF |
| / | B33-603-499YL | Yellow | – | – | | 15.70 | 3000 | B30-R6000HF |
| B-593: Polyester | | | | | | | | |
| ▲ | B30EP-171-593-BK | Black | 26.92 | 12.45 | | 19.05 | 500 | B30 Monocolour Series |
| ▲ | B30EP-171-593-SL | Silver | 26.92 | 12.45 | | 19.05 | 500 | B30 Monocolour Series |
| ▲ | B30EP-171-593-WT | White | 26.92 | 12.45 | | 19.05 | 500 | B30 Monocolour Series |
| B-595: Vinyl | | | | | | | | |
| ∞ | B30C-500-595-WT | White | 12.70 | – | 30.48 m | – | 1 | B30-R10000 |
| ∞ | B30C-500-595-YL | Yellow | 12.70 | – | 30.48 m | – | 1 | B30-R10000 |



Self-laminating wire & cable markers

Brady's most popular wire marker

- Features white printable area with clear "tail" that wraps around marker to protect text
- Superior resistance to abrasion, handling, solvents, water, oil and dirt
- B-427 uses a permanent acrylic adhesive designed specifically for tightly curved surfaces
- B-417 offers an extra-strong permanent adhesive acrylic adhesive ideal for small-gauge wires

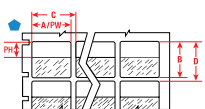

| Diagram | Order Reference | Colour | Label Width A (mm) | Label Height B (mm) | Printable Area Height PH (mm) | Vertical Repeat D (mm) | Labels per Roll | Printer Ribbon Series |
|-------------------------------------|-----------------|--------------------|-----------------------|------------------------|----------------------------------|---------------------------|--------------------|--------------------------|
| B-417: Self-laminating Vinyl | | | | | | | | |
| ● | B33-80-417 | White, Transparent | 12.70 | 19.05 | 9.53 | 24.13 | 2500 | B30 Monocolour Series |
| ● | B33-114-417 | White, Transparent | 12.70 | 31.75 | 12.70 | 34.93 | 4000 | B30 Monocolour Series |
| ● | B33-8-417 | White, Transparent | 12.70 | 36.50 | 12.70 | 41.28 | 5000 | B30 Monocolour Series |

>>

Self-laminating wire & cable markers (Continued)

Brady's most popular wire marker

| Diagram | Order Reference | Colour | Label Width A (mm) | Label Height B (mm) | Printable Area Height PH (mm) | Vertical Repeat D (mm) | Labels per Roll | Printer Ribbon Series |
|-------------------------------------|-----------------|--------------------|--------------------|---------------------|-------------------------------|------------------------|-----------------|-----------------------|
| ◆ | B33-56-417 | White, Transparent | 19.05 | 23.80 | 9.53 | 28.58 | 5000 | B30 Monocolour Series |
| ◆ | B33-73-417 | White, Transparent | 19.05 | 44.45 | 12.70 | 47.63 | 3500 | B30 Monocolour Series |
| ◆ | B33-116-417 | White, Transparent | 25.40 | 25.40 | 9.53 | 28.58 | 2500 | B30 Monocolour Series |
| ◆ | B33-117-417 | White, Transparent | 25.40 | 31.75 | 12.70 | 34.93 | 2000 | B30 Monocolour Series |
| ◆ | B33-9-417 | White, Transparent | 25.40 | 36.50 | 12.70 | 41.28 | 2500 | B30 Monocolour Series |
| ◆ | B33-75-417 | White, Transparent | 25.40 | 57.15 | 19.05 | 60.33 | 1400 | B30 Monocolour Series |
| ◆ | B33-10-417 | White, Transparent | 25.40 | 95.25 | 25.40 | 101.60 | 1200 | B30 Monocolour Series |
| ◆ | B33-81-417 | White, Transparent | 25.40 | 152.40 | 38.10 | 157.15 | 500 | B30 Monocolour Series |
| ▷ | B33-119-417 | White, Transparent | 38.10 | 38.10 | 12.70 | 41.28 | 1000 | B30 Monocolour Series |
| ▷ | B33-27-417 | White, Transparent | 50.80 | 95.25 | 25.40 | 101.60 | 400 | B30 Monocolour Series |
| ▷ | B33-26-417 | White, Transparent | 63.50 | 57.15 | 19.05 | 61.93 | 500 | B30 Monocolour Series |
| B-427: Self-laminating Vinyl | | | | | | | | |
| ▷ | B33-8-427 | White, Transparent | 12.70 | 36.50 | 12.70 | 41.30 | 5000 | B30 Monocolour Series |
| ▷ | B33-80-427 | White, Transparent | 12.70 | 19.05 | 9.53 | 24.13 | 2500 | B30 Monocolour Series |
| ▷ | B33-113-427 | White, Transparent | 12.70 | 25.40 | 9.53 | 28.58 | 2500 | B30 Monocolour Series |
| ◆ | B33-114-427 | White, Transparent | 12.70 | 31.75 | 12.70 | 34.93 | 4000 | B30 Monocolour Series |
| ▷ | B33-73-427 | White, Transparent | 19.05 | 44.45 | 12.70 | 47.60 | 3500 | B30 Monocolour Series |
| ▷ | B33-56-427 | White, Transparent | 19.05 | 23.80 | 9.53 | 28.58 | 5000 | B30 Monocolour Series |
| ▷ | B33-74-427 | White, Transparent | 20.32 | 36.50 | 12.70 | 41.30 | 4000 | B30 Monocolour Series |
| ▷ | B33-115-427 | White, Transparent | 25.40 | 19.05 | 9.53 | 21.59 | 2500 | B30 Monocolour Series |
| ▷ | B33-131-427 | White, Transparent | 25.40 | 66.68 | 25.40 | 28.58 | 1500 | B30 Monocolour Series |
| ▷ | B33-9-427 | White, Transparent | 25.40 | 36.50 | 12.70 | 41.30 | 2500 | B30 Monocolour Series |
| ▷ | B33-81-427 | White, Transparent | 25.40 | 152.40 | 38.10 | 157.10 | 500 | B30 Monocolour Series |
| ▷ | B33-75-427 | White, Transparent | 25.40 | 57.15 | 19.05 | 60.30 | 1400 | B30 Monocolour Series |
| ▷ | B33-10-427 | White, Transparent | 25.40 | 95.25 | 25.40 | 101.60 | 1200 | B30 Monocolour Series |
| ▷ | B33-116-427 | White, Transparent | 25.40 | 25.40 | 9.53 | 28.58 | 2500 | B30 Monocolour Series |
| ▷ | B33-117-427 | White, Transparent | 25.40 | 31.75 | 12.70 | 34.93 | 2000 | B30 Monocolour Series |
| ▷ | B33-211-427 | White, Transparent | 25.40 | 25.40 | 9.65 | 32.13 | 3000 | B30-R4300 |
| ▷ | B33-311-427 | White, Transparent | 25.40 | 31.75 | 12.70 | 37.72 | 3000 | B30-R4300 |
| ▷ | B33-511-427 | White, Transparent | 25.40 | 63.50 | 19.05 | 70.64 | 1500 | B30-R4300 |
| ▲ | B33-135-427AW | White | 38.10 | 19.05 | 19.05 | 22.23 | 1500 | B30 Monocolour Series |
| ▷ | B33-272-427 | White, Transparent | 38.10 | 57.15 | 19.05 | 63.50 | 700 | B30 Monocolour Series |
| ▷ | B33-119-427 | White, Transparent | 38.10 | 38.10 | 12.70 | 44.45 | 1000 | B30 Monocolour Series |
| ▷ | B33-118-427 | White, Transparent | 38.10 | 25.40 | 9.53 | 28.58 | 1250 | B30 Monocolour Series |
| ▷ | B33-517-427 | White, Transparent | 38.10 | 63.50 | 19.05 | 69.85 | 1000 | B30-R4300 |
| ▷ | B33-273-427 | White, Transparent | 44.45 | 57.15 | 19.05 | 63.50 | 500 | B30 Monocolour Series |
| ▷ | B33-121-427 | White, Transparent | 44.45 | 38.10 | 12.70 | 44.45 | 1000 | B30 Monocolour Series |
| ▷ | B33-120-427 | White, Transparent | 44.45 | 25.40 | 9.53 | 28.58 | 1250 | B30 Monocolour Series |
| ▲ | B33-137-427AW | White | 50.80 | 25.40 | 25.40 | 28.58 | 1500 | B30 Monocolour Series |
| ▷ | B33-82-427 | White, Transparent | 50.80 | 152.40 | 38.10 | 157.15 | 200 | B30 Monocolour Series |
| ▷ | B33-27-427 | White, Transparent | 50.80 | 95.25 | 25.40 | 101.60 | 400 | B30 Monocolour Series |
| ▲ | B33-640-427AW | White | 55.88 | 38.10 | – | 45.08 | 1500 | B30-R4300 |
| ▷ | B33-26-427 | White, Transparent | 63.50 | 57.15 | 19.05 | 61.90 | 500 | B30 Monocolour Series |
| ▲ | B33-648-427AW | White | 66.68 | 25.40 | – | 32.38 | 1500 | B30-R4300 |

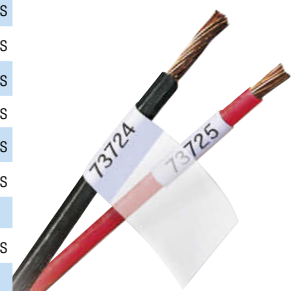
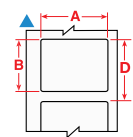
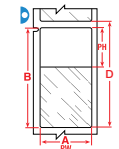
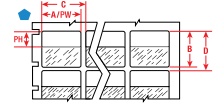

B-425 Fibre optic labels

Ideal for marking fibre optic cables

- Allows you to handle and view labels without touching the wires.

| Diagram | Order Reference | Colour | Label Width A (mm) | Label Height B (mm) | Vertical Repeat D (mm) | Labels per Roll | Printer Ribbon Series |
|------------------------------|-----------------|--------|--------------------|---------------------|------------------------|-----------------|-----------------------|
| B-425A: Polypropylene | | | | | | | |
| └ | B33FP-01-425 | White | 30.00 | 10.00 | 26.03 | 1000 | B30-R4300 |
| T | B33FT-01-425 | White | 30.00 | 10.00 | 46.03 | 1000 | B30-R4300 |

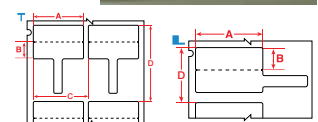

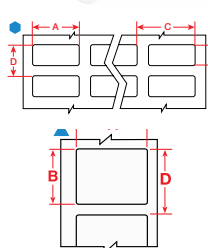
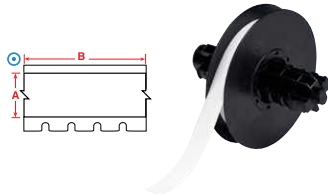
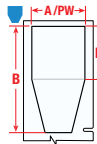
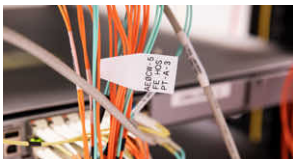
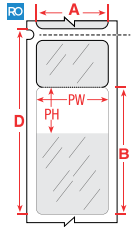

B-427 rotating self-laminating labels

Legible from any angle: identify cables faster

- The B-427 self-laminating Rotating Label version can increase the speed of cable identification because its print can be read from any angle.
- The label can be rotated around a cable thanks to a non-adhesive printable zone and a translucent, self-adhesive laminate that is wrapped around a cable.

| Diagram | Order Reference | Colour | Label Width A (mm) | Label Height B (mm) | Printable Area Height PH (mm) | Vertical Repeat D (mm) | Labels per Roll | Printer Ribbon Series |
|------------------------------|-----------------|--------------------|--------------------|---------------------|-------------------------------|------------------------|-----------------|-----------------------|
| B-427: Self-laminating Vinyl | | | | | | | | |
| RO | B33RO-292-427 | White, Transparent | 12.70 | 44.45 | 17.78 | 65.41 | 1500 | R4300 |
| RO | B33RO-293-427 | White, Transparent | 12.70 | 69.85 | 27.94 | 100.97 | 900 | R4300 |
| RO | B33RO-294-427 | White, Transparent | 25.40 | 44.45 | 17.78 | 65.41 | 1000 | R4300 |
| RO | B33RO-295-427 | White, Transparent | 25.40 | 69.85 | 27.94 | 100.97 | 700 | R4300 |
| RO | B33RO-296-427 | White, Transparent | 25.40 | 79.38 | 31.75 | 114.30 | 600 | R4300 |
| RO | B33RO-297-427 | White, Transparent | 25.40 | 30.48 | 12.70 | 46.36 | 600 | R4300 |
| RO | B33RO-299-427 | White, Transparent | 50.80 | 79.38 | 31.75 | 114.30 | 250 | R4300 |

B-483 QuickFlag tapered wire and cable flag labels

One-sided labels

- Quickly flag wires and cables with the B-483 QuickFlag™ label material, featuring a tapered design to prevent mismatched edges and make flag installation much faster.

| Diagram | Order Reference | Colour | Label Width A (mm) | Label Height B (mm) | Printable Area Height PH (mm) | Printable Area Width PW (mm) | Labels per Roll |
|-------------------|-----------------|--------------------|--------------------|---------------------|-------------------------------|------------------------------|-----------------|
| B-483A: Polyester | | | | | | | |
| | B33-360-483 | White, Transparent | 25.40 | 50.80 | 25.40 | 25.40 | 1500 |
| | B33-361-483 | White, Transparent | 48.26 | 50.80 | 25.40 | 48.26 | 1500 |

B-498 Adhesive terminal block markers

Holds strong but can be removed cleanly and re-applied

- Specially designed narrow-width continuous label for alignment on terminal blocks and patch panels
- Highly unique adhesive and cloth construction gives excellent holding power and still allows for clean removal and re-application

| Diagram | Order Reference | Colour | Label Width A (mm) | Label Length B (m) | Vertical Repeat D (mm) | Labels per Roll | Printer Ribbon Series |
|--------------------|-----------------|--------|--------------------|--------------------|------------------------|-----------------|-----------------------|
| B-498: Vinyl Cloth | | | | | | | |
| ⊙ | B33C-312-498 | White | 7.92 | 25.91 m | – | 1 | B30-R6200 |
| ⊙ | B33C-375-498 | White | 9.53 | 25.91 m | – | 1 | B30-R6200 |

B-498 Repositionable vinyl cloth wire & cable markers

Holds strong but can be removed cleanly and re-applied

- A vinyl cloth label for marking wires, cables and inside-panel components
- Highly unique adhesive and cloth construction gives excellent holding power and still allows for clean removal and re-application
- Ideal choice for marking both ends of a wire that you may need to cut shorted before final termination

| Diagram | Order Reference | Colour | Label Width A (mm) | Label Height B (mm) | Vertical Repeat D (mm) | Labels per Roll | Printer Ribbon Series |
|--------------------|-----------------|--------|--------------------|---------------------|------------------------|-----------------|-----------------------|
| B-498: Vinyl Cloth | | | | | | | |
| ⬢ | B33-1-498 | White | 19.05 | 6.35 | 8.89 | 5000 | B30 Monocolour Series |
| ▲ | B33-254-498 | White | 19.05 | 19.05 | 21.59 | 1000 | B30 Monocolour Series |
| ⬢ | B33-325-498 | White | 25.40 | 63.50 | 66.68 | 700 | B30 Monocolour Series |
| ⬢ | B33-326-498 | White | 25.40 | 101.60 | 104.78 | 450 | B30 Monocolour Series |
| ⬢ | B33-327-498 | White | 38.10 | 101.60 | 104.78 | 450 | B30 Monocolour Series |
| ⬢ | B33-5-498 | White | 25.40 | 12.70 | 15.24 | 5000 | B30 Monocolour Series |
| ⬢ | B33-68-498 | White | 12.70 | 19.05 | 21.59 | 5000 | B30 Monocolour Series |
| ⬢ | B33-87-498 | White | 12.70 | 36.50 | 39.70 | 2500 | B30 Monocolour Series |
| ⬢ | B33-88-498 | White | 25.40 | 19.05 | 22.23 | 2500 | B30 Monocolour Series |
| ⬢ | B33-89-498 | White | 25.40 | 36.50 | 39.70 | 2300 | B30 Monocolour Series |
| ⬢ | B33-90-498 | White | 6.35 | 36.50 | 39.70 | 2500 | B30 Monocolour Series |
| ⬢ | B33-91-498 | White | 19.05 | 23.80 | 27.00 | 2500 | B30 Monocolour Series |
| ⬢ | B33-95-498 | White | 20.32 | 36.50 | 39.70 | 2300 | B30 Monocolour Series |

B-499 Wire & cable markers

This nylon cloth material has superb adhesive power, making it a flexible all surfaces solution

| Diagram | Order Reference | Colour | Label Width A (mm) | Label Height B (mm) | Vertical Repeat D (mm) | Labels per Roll | Printer Ribbon Series |
|--------------------|-----------------|--------|--------------------|---------------------|------------------------|-----------------|-----------------------|
| B-499: Nylon Cloth | | | | | | | |
| | B33-87-499 | White | 12.70 | 36.50 | 39.67 | 2500 | B30 Monocolour Series |
| | B33-611-499 | White | 12.70 | 25.40 | 28.40 | 3000 | B30-R6000HF |
| | B33-620-499 | White | 12.70 | 25.40 | 28.40 | 1000 | B30-R6000HF |
| | B33-1-499 | White | 19.05 | 6.35 | 8.89 | 10000 | B30 Monocolour Series |
| | B33-254-499 | White | 19.05 | 19.05 | 21.59 | 1000 | B30 Monocolour Series |
| | B33-91-499 | White | 19.05 | 23.80 | 26.97 | 2500 | B30 Monocolour Series |
| | B33-125-499 | White | 22.86 | 12.70 | 15.24 | 1500 | B30 Monocolour Series |
| | B33-152-499 | White | 25.40 | 9.53 | 12.07 | 1500 | B30 Monocolour Series |
| | B33-5-499 | White | 25.40 | 12.70 | 15.24 | 5000 | B30 Monocolour Series |
| | B33-88-499 | White | 25.40 | 19.05 | 22.23 | 2500 | B30 Monocolour Series |
| | B33-89-499 | White | 25.40 | 36.58 | 39.67 | 2300 | B30 Monocolour Series |
| | B33-325-499 | White | 25.40 | 63.50 | 66.68 | 700 | B30 Monocolour Series |
| | B33-326-499 | White | 25.40 | 101.60 | 104.78 | 450 | B30 Monocolour Series |
| | B33-621-499 | White | 25.40 | 36.50 | 39.50 | 3000 | B30-R6000HF |
| | B33-625-499 | White | 25.40 | 66.68 | 69.68 | 1500 | B30-R6000HF |
| | B33-659-499 | White | 25.40 | 12.45 | 15.40 | 1000 | B30-R6000HF |
| | B33-327-499 | White | 38.10 | 101.60 | 104.78 | 450 | B30 Monocolour Series |
| | B33-328-499 | White | 38.10 | 152.40 | 155.58 | 300 | B30 Monocolour Series |
| | B33-151-499 | White | 50.80 | 6.35 | 8.89 | 1500 | B30 Monocolour Series |
| | B33-90-499 | White | 6.35 | 36.50 | 39.67 | 2500 | B30 Monocolour Series |

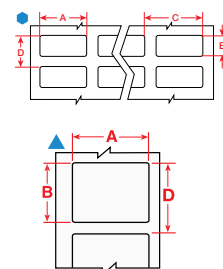

B-437 Tedlar adhesive wire & cable labels

Topcoated Polyvinylfluoride label for wire & cable marking where high temperature and self-extinguishing features are required

- Heavy duty performance with excellent resistance to water, oil and other fluids
- Meets MIL-M-87958 Standard

| Diagram | Order Reference | Colour | Label Width A (mm) | Label Height B (mm) | Label Length B (m) | Vertical Repeat D (mm) | Labels per Roll | Printer Ribbon Series |
|--------------------------|-----------------|--------|--------------------|---------------------|--------------------|------------------------|-----------------|-----------------------|
| B-437: Polyvinylfluoride | | | | | | | | |
| | B30C-4000-437 | White | 101.60 | - | 45.72 m | - | 1 | B30-R4300 |
| | B33-11-437 | White | 6.35 | 6.35 | - | 9.53 | 15000 | B30 Monocolour Series |
| | B33-1-437 | White | 19.05 | 6.35 | - | 8.89 | 5000 | B30 Monocolour Series |
| | B33-29-437 | White | 31.75 | 9.53 | - | 12.07 | 5000 | B30 Monocolour Series |
| | B33-29-437YL | Yellow | 31.75 | 9.53 | - | 12.07 | 5000 | B30 Monocolour Series |
| | B33-5-437 | White | 25.40 | 12.70 | - | 15.19 | 5000 | B30 Monocolour Series |
| | B33-5-437YL | Yellow | 25.40 | 12.70 | - | 15.19 | 5000 | B30 Monocolour Series |
| | B33C-1000-437 | White | 25.40 | - | 25.91 m | - | 1 | B30-R4300 |
| | B33C-1000-437YL | Yellow | 25.40 | - | 25.91 m | - | 1 | B30-R4300 |
| | B33C-1500-437 | White | 38.10 | - | 25.91 m | - | 1 | B30-R4300 |
| | B33C-2000-437 | White | 50.80 | - | 25.91 m | - | 1 | B30-R4300 |
| | B33C-2000-437YL | Yellow | 50.80 | - | 25.91 m | - | 1 | B30-R4300 |
| | B33C-3000-437 | White | 76.20 | - | 25.91 m | - | 1 | B30-R4300 |

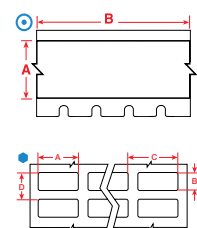

B-7599 Polyethylene tag

Rapido wire marking sleeves

| Diagram | Order Reference | Colour | Label Width A (mm) | Label Height B (mm) | Vertical Repeat D (mm) | Labels per Roll | Printer Ribbon Series |
|----------------------|-----------------|--------|--------------------|---------------------|------------------------|-----------------|-----------------------|
| B-7599: Polyethylene | | | | | | | |
| | B33R-01-7599-YL | Yellow | 23.00 | 5.20 | 8.39 | 2500 | B30-R4300, B30-R6200 |
| | B33R-02-7599-YL | Yellow | 23.00 | 5.20 | 8.39 | 2500 | B30-R4300, B30-R6200 |
| | B33R-03-7599-YL | Yellow | 25.00 | 5.70 | 8.89 | 2500 | B30-R4300, B30-R6200 |

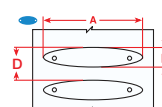



B-472 Polyimide high temp adhesive wire & cable labels

Topcoated Polyimide label for wire & cable marking where high temperature and self-extinguishing features are required

- Heavy duty performance with excellent resistance to water, oil and other fluids

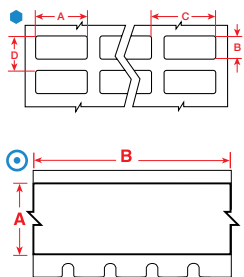

| Diagram | Order Reference | Colour | Label Width A (mm) | Label Height B (mm) | Label Length B (m) | Vertical Repeat D (mm) | Labels per Roll | Printer Ribbon Series |
|------------------|-----------------|--------|--------------------|---------------------|--------------------|------------------------|-----------------|-----------------------|
| B-472: Polyimide | | | | | | | | |
| ● | B33-11-472 | White | 6.35 | 6.35 | | 9.53 | 15000 | B30 Monocolour Series |
| ● | B33-1-472 | White | 19.05 | 6.35 | | 8.89 | 5000 | B30 Monocolour Series |
| ● | B33-2-472 | White | 22.86 | 6.35 | | 8.89 | 5000 | B30 Monocolour Series |
| ● | B33-29-472 | White | 31.75 | 9.53 | | 12.07 | 5000 | B30 Monocolour Series |
| ● | B33-5-472 | White | 25.40 | 12.70 | | 15.24 | 5000 | B30 Monocolour Series |
| ● | B33-5-472-YL | Yellow | 25.40 | 12.70 | | 15.24 | 5000 | B30 Monocolour Series |
| ⊙ | B33C-1000-472 | White | 25.40 | – | 25.91 m | – | 1 | B30-R4300 |
| ⊙ | B33C-1000-472YL | Yellow | 25.40 | – | 25.91 m | – | 1 | B30-R4300 |
| ⊙ | B33C-1500-472 | White | 38.10 | – | 25.91 m | – | 1 | B30-R4300 |
| ⊙ | B33C-1500-472YL | Yellow | 38.10 | – | 25.91 m | – | 1 | B30-R4300 |
| ⊙ | B33C-2000-472 | White | 50.80 | – | 25.91 m | – | 1 | B30-R4300 |
| ⊙ | B33C-2000-472YL | Yellow | 50.80 | – | 25.91 m | – | 1 | B30-R4300 |
| ⊙ | B33C-3000-472 | White | 76.20 | – | 25.91 m | – | 1 | B30-R4300 |
| ⊙ | B33C-3000-472YL | Yellow | 76.20 | – | 25.91 m | – | 1 | B30-R4300 |



B-7597 Tear resistant tags

This tag can be used for a variety of applications including identification of multi-conductor cables, inventory and equipment

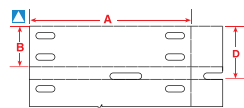

| Diagram | Order Reference | Colour | Label Width A (mm) | Label Height B (mm) | Vertical Repeat D (mm) | Labels per Roll | Printer Ribbon Series |
|----------------------|-----------------|--------|--------------------|---------------------|------------------------|-----------------|-----------------------|
| B-7597: Polyethylene | | | | | | | |
| ▲ | B33-7597W-2050 | White | 50.80 | 12.70 | 16.72 | 2000 | B30-R4300 |



B-7598 Polyester cable tag

Durable outdoor cable identification

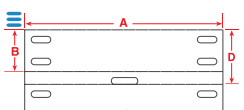

| Diagram | Order Reference | Colour | Label Width A (mm) | Label Height B (mm) | Vertical Repeat D (mm) | Labels per Roll | Printer Ribbon Series |
|-------------------|-------------------|--------|--------------------|---------------------|------------------------|-----------------|-----------------------|
| B-7598: Polyester | | | | | | | |
| ≡ | B33-60X10-7598-BK | Black | 60.00 | 10.00 | 15.08 | 1000 | B30-R4400-WT |
| ≡ | B33-60X10-7598-BL | Blue | 60.00 | 10.00 | 15.08 | 1000 | B30-R6000HF |
| ≡ | B33-60X10-7598-GN | Green | 60.00 | 10.00 | 15.08 | 1000 | B30-R6000HF |
| ≡ | B33-60X10-7598-RD | Red | 60.00 | 10.00 | 15.08 | 1000 | B30-R6000HF |
| ≡ | B33-60X10-7598-SV | Silver | 60.00 | 10.00 | 15.08 | 1000 | B30-R6000HF |
| ≡ | B33-60X10-7598-WT | White | 60.00 | 10.00 | 15.08 | 1000 | B30-R6000HF |
| ≡ | B33-60X10-7598-YL | Yellow | 60.00 | 10.00 | 15.08 | 1000 | B30-R6000HF |
| ≡ | B33-75X10-7598-BK | Black | 75.00 | 10.00 | 15.08 | 1000 | B30-R4400-WT |
| ≡ | B33-75X10-7598-BL | Blue | 75.00 | 10.00 | 15.08 | 1000 | B30-R6000HF |
| ≡ | B33-75X10-7598-GN | Green | 75.00 | 10.00 | 15.08 | 1000 | B30-R6000HF |
| ≡ | B33-75X10-7598-RD | Red | 75.00 | 10.00 | 15.08 | 1000 | B30-R6000HF |
| ≡ | B33-75X10-7598-SV | Silver | 75.00 | 10.00 | 15.08 | 1000 | B30-R6000HF |
| ≡ | B33-75X10-7598-WT | White | 75.00 | 10.00 | 15.08 | 1000 | B30-R6000HF |
| ≡ | B33-75X10-7598-YL | Yellow | 75.00 | 10.00 | 15.08 | 1000 | B30-R6000HF |
| ≡ | B33-75X15-7598-BK | Black | 75.00 | 15.00 | 20.02 | 1000 | B30-R4400-WT |

>>

B-7598 Polyester cable tag (Continued)

Durable outdoor cable identification



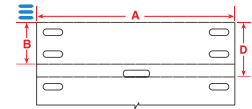























| Diagram | Order Reference | Colour | Label Width A (mm) | Label Height B (mm) | Vertical Repeat D (mm) | Labels per Roll | Printer Ribbon Series |
|---|-------------------|--------|--------------------|---------------------|------------------------|-----------------|-----------------------|
|  | B33-75X15-7598-BL | Blue | 75.00 | 15.00 | 20.02 | 1000 | B30-R6000HF |
|  | B33-75X15-7598-GN | Green | 75.00 | 15.00 | 20.02 | 1000 | B30-R6000HF |
|  | B33-75X15-7598-RD | Red | 75.00 | 15.00 | 20.02 | 1000 | B30-R6000HF |
|  | B33-75X15-7598-SV | Silver | 75.00 | 15.00 | 20.02 | 1000 | B30-R6000HF |
|  | B33-75X15-7598-WT | White | 75.00 | 15.00 | 20.02 | 1000 | B30-R6000HF |
|  | B33-75X15-7598-YL | Yellow | 75.00 | 15.00 | 20.02 | 1000 | B30-R6000HF |
|  | B33-75X25-7598-BK | Black | 75.00 | 25.00 | 30.16 | 500 | B30-R4400-WT |
|  | B33-75X25-7598-BL | Blue | 75.00 | 25.00 | 30.16 | 500 | B30-R6000HF |
|  | B33-75X25-7598-GN | Green | 75.00 | 25.00 | 30.16 | 500 | B30-R6000HF |
|  | B33-75X25-7598-RD | Red | 75.00 | 25.00 | 30.16 | 500 | B30-R6000HF |
|  | B33-75X25-7598-SV | Silver | 75.00 | 25.00 | 30.16 | 500 | B30-R6000HF |
|  | B33-75X25-7598-WT | White | 75.00 | 25.00 | 30.16 | 500 | B30-R6000HF |
|  | B33-75X25-7598-YL | Yellow | 75.00 | 25.00 | 30.16 | 500 | B30-R6000HF |



B-7643 Halogen-free cable tag

Easily print cable tags wherever you are



| Diagram | Order Reference | Colour | Label Width A (mm) | Label Height B (mm) | Vertical Repeat D (mm) | Labels per Roll | Printer Ribbon Series |
|---|-------------------|--------|--------------------|---------------------|------------------------|-----------------|-----------------------|
| B-7643: Thermoplastic Polyether Polyurethane | | | | | | | |
|  | B33-60X10-7643-BK | Black | 60.00 | 10.00 | 15.08 | 750 | B30-R4400-WT |
|  | B33-60X10-7643-BL | Blue | 60.00 | 10.00 | 15.08 | 750 | B30-R6000HF |
|  | B33-60X10-7643-GN | Green | 60.00 | 10.00 | 15.08 | 750 | B30-R6000HF |
|  | B33-60X10-7643-OR | Orange | 60.00 | 10.00 | 15.08 | 750 | B30-R6000HF |
|  | B33-60X10-7643-RD | Red | 60.00 | 10.00 | 15.08 | 750 | B30-R6000HF |
|  | B33-60X10-7643-YL | Yellow | 60.00 | 10.00 | 15.08 | 750 | B30-R6000HF |
|  | B33-75X10-7643-BK | Black | 75.00 | 10.00 | 15.08 | 750 | B30-R4400-WT |
|  | B33-75X15-7643-BK | Black | 75.00 | 15.00 | 20.02 | 500 | B30-R4400-WT |
|  | B33-75X25-7643-BK | Black | 75.00 | 25.00 | 30.16 | 250 | B30-R4400-WT |
|  | B33-75X10-7643-BL | Blue | 75.00 | 10.00 | 15.08 | 750 | B30-R6000HF |
|  | B33-75X15-7643-BL | Blue | 75.00 | 15.00 | 20.02 | 500 | B30-R6000HF |
|  | B33-75X25-7643-BL | Blue | 75.00 | 25.00 | 30.16 | 250 | B30-R6000HF |
|  | B33-75X10-7643-GN | Green | 75.00 | 10.00 | 15.08 | 750 | B30-R6000HF |
|  | B33-75X15-7643-GN | Green | 75.00 | 15.00 | 20.02 | 500 | B30-R6000HF |
|  | B33-75X25-7643-GN | Green | 75.00 | 25.00 | 30.16 | 250 | B30-R6000HF |
|  | B33-75X10-7643-OR | Orange | 75.00 | 10.00 | 15.08 | 750 | B30-R6000HF |
|  | B33-75X15-7643-OR | Orange | 75.00 | 15.00 | 20.02 | 500 | B30-R6000HF |
|  | B33-75X25-7643-OR | Orange | 75.00 | 25.00 | 30.16 | 250 | B30-R6000HF |
|  | B33-75X10-7643-RD | Red | 75.00 | 10.00 | 15.08 | 750 | B30-R6000HF |
|  | B33-75X15-7643-RD | Red | 75.00 | 15.00 | 20.02 | 500 | B30-R6000HF |
|  | B33-75X25-7643-RD | Red | 75.00 | 25.00 | 30.16 | 250 | B30-R6000HF |
|  | B33-75X10-7643-WT | White | 75.00 | 10.00 | 15.08 | 750 | B30-R6000HF |
|  | B33-75X15-7643-WT | White | 75.00 | 15.00 | 20.02 | 500 | B30-R6000HF |
|  | B33-75X25-7643-WT | White | 75.00 | 25.00 | 30.16 | 250 | B30-R6000HF |
|  | B33-75X10-7643-YL | Yellow | 75.00 | 10.00 | 15.08 | 750 | B30-R6000HF |
|  | B33-75X15-7643-YL | Yellow | 75.00 | 15.00 | 20.02 | 500 | B30-R6000HF |
|  | B33-75X25-7643-YL | Yellow | 75.00 | 25.00 | 30.16 | 250 | B30-R6000HF |





B-348 Mass transit cable tag

Fully compliant mass transit tag

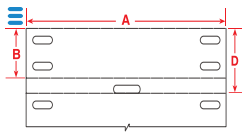

| Diagram | Order Reference | Colour | Label Width A (mm) | Label Height B (mm) | Vertical Repeat D (mm) | Labels per Roll | Printer Ribbon Series |
|--------------------------|-----------------|--------|--------------------|---------------------|------------------------|-----------------|-----------------------|
| B-348: Polyolefin | | | | | | | |
| | B33-6010-348-WT | White | 60.00 | 10.00 | 15.08 | 750 | B30-R6000HF |
| | B33-6010-348-YL | Yellow | 60.00 | 10.00 | 15.08 | 750 | B30-R6000HF |
| | B33-7510-348-WT | White | 75.00 | 10.00 | 15.08 | 750 | B30-R6000HF |
| | B33-7510-348-YL | Yellow | 75.00 | 10.00 | 15.08 | 750 | B30-R6000HF |
| | B33-7515-348-WT | White | 75.00 | 15.00 | 20.02 | 500 | B30-R6000HF |
| | B33-7515-348-YL | Yellow | 75.00 | 15.00 | 20.02 | 500 | B30-R6000HF |
| | B33-7525-348-WT | White | 75.00 | 25.00 | 30.16 | 250 | B30-R6000HF |
| | B33-7525-348-YL | Yellow | 75.00 | 25.00 | 30.16 | 250 | B30-R6000HF |



B-345 PermaSleeve HT high temperature PVDF wire marking sleeves

High temperature, low outgassing. 2:1 Shrink Ratio

- A 2:1 shrink ratio wire marker sleeve specifically designed for high temperature and low vacuum outgassing applications
- Made from irradiated high-temp Polyvinylidene Fluoride (PVDF) heat shrink tubing
- Fade-resistant and flame-retardant

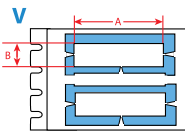

| Diagram | Order Reference | Colour | Label Width A (mm) | Label Height B (mm) | Vertical Repeat D (mm) | Labels per Roll | Printer Ribbon Series |
|---|-----------------|--------|--------------------|---------------------|------------------------|-----------------|-----------------------|
| B-345: High Temperature Heat-shrink Polyvinylidene Fluoride Sleeve | | | | | | | |
| | B33D-125-2-345 | White | 50.80 | 5.97 | 12.70 | 1000 | B30-R6000HF |
| | B33D-187-2-345 | White | 50.80 | 8.51 | 15.88 | 750 | B30-R6000HF |
| | B33D-250-2-345 | White | 50.80 | 11.15 | 19.05 | 500 | B30-R6000HF |
| | B33D-375-2-345 | White | 50.80 | 16.38 | 25.40 | 500 | B30-R6000HF |
| | B33D-500-2-345 | White | 50.80 | 21.62 | 31.75 | 350 | B30-R6000HF |
| | B33D-750-2-345 | White | 50.80 | 31.75 | 41.28 | 250 | B30-R6000HF |
| | B33D-94-2-345 | White | 50.80 | 4.62 | 12.70 | 1000 | B30-R6000HF |

*This size is only 3:1 shrink ratio

▶ How to read your PermaSleeve order reference

Example order reference:

B33D - 187 - 2 - BK - 4
 Product Diameter Width Colour Pieces
 (Optional)

Order reference components PermaSleeve wire marking sleeves:

| Product type |
|------------------------------|
| B33 = Single-sided Printing |
| B33D = Double-sided Printing |

| Sleeve width |
|--------------|
| 2 = 50.80mm |

| Sleeve diameter |
|--|
| 094 = 3/32" size fits wire diameter 0.58mm - 2.03mm |
| 125 = 1/8" size fits wire diameter 1.17mm - 2.79mm |
| 187 = 3/16" size fits wire diameter 1.57mm - 3.81mm |
| 250 = 1/4" size fits wire diameter 2.39mm - 5.46mm |
| 375 = 3/8" size fits wire diameter 3.18mm - 8.13mm |
| 500 = 1/2" size fits wire diameter 4.75mm - 11.43mm |
| 750 = 3/4" size fits wire diameter 6.35mm - 17.78mm |
| 1000 = 1" size fits wire diameter 9.53mm - 24.13mm |
| 1500 = 1 1/2" size fits wire diameter 12.7mm - 36.83mm |

| Sleeve Colour |
|---|
| BK = Black WT = White YL = Yellow |

Optional: Pieces Per Sleeve
 While 1 marker per sleeve is standard, the sleeve can be split into multiple pieces.
 Example: B33-1500-2-342-2 This "2" means that this 50.80mm sleeve is slit into two 25.40mm pieces

How to select a wire marker

There are four main questions to ask yourself when you're starting the process of marking wires. These questions will help you select a wire marker that best suits your needs.

1. Are you marking the wire after termination?

Sleeve markers can only be used before termination because they must be slipped over the open end of the wire. These non-adhesive markers provide flexibility as they can be moved prior to being heat-shrunk. Once shrunk, these markers fit snugly around wires for permanent identification which will stand up to harsh environments.

2. What size of wire are you marking?

The diameter of the wire determines the size of the sleeve or the height of the label to be used.

3. Will you print your own markers or purchase preprinted ones?

Pre-printed markers are available in a large variety of stock legends, and custom legends are available for any large jobs. These markers come in a variety of packaging and formats for ease of use and ease of transport. They are ideal for any application.

Printable markers are meant to be printed with variable legends as needed. Various methods for this include: portable wire marking printers or computer software linked to thermal transfer, dot matrix or laser-printers. An extensive array of sizes are available for every application. These printable markers offer the flexibility of printing legends on demand. They are also ideal for applications that require long legends.

4. In what type of environment will these wire markers be placed?

It is extremely important to select a wire marker material that will last for your application. Too many companies go to the trouble of marking only to have to do it all again because they did not select the correct material. Be sure to ask yourself these questions before you select your wire marker.

How to select a marker size

Brady offers a variety of marker sizes for your wire marking needs. Please view the chart listed below to assist you in choosing the minimum recommended flattened sleeve height for the wire or cable that you are identifying.

| Sleeve code | Flattened Sleeve Height (mm) | Max. Wire/Cable Diameter (mm) | Min. Wire/Cable Diameter (mm) |
|---|------------------------------|-------------------------------|-------------------------------|
| B-342 PermaSleeve™ PS Polyolefin Wire Marking Sleeves | | | |
| 094 | 4.62 | 2.03 | 0.58 |
| 125 | 5.97 | 2.79 | 1.17 |
| 187 | 8.51 | 3.81 | 1.57 |
| 250 | 11.15 | 5.46 | 2.39 |
| 375 | 16.38 | 8.13 | 3.18 |
| 500 | 21.62 | 11.43 | 4.75 |
| 750 | 31.75 | 17.78 | 6.35 |
| 1000 | 42.16 | 24.13 | 9.53 |
| 1500 | 61.80 | 36.83 | 12.70 |
| B-345 PermaSleeve™ High Temperature PVDF Wire Marking Sleeves | | | |
| 094 | 4.62 | 2.00 | 0.60 |
| 125 | 5.97 | 2.80 | 1.57 |
| 187 | 8.51 | 3.80 | 2.40 |
| 250 | 11.15 | 5.50 | 3.18 |
| 375 | 16.38 | 8.10 | 4.75 |
| 500 | 21.62 | 11.40 | 6.35 |
| 750 | 31.75 | 17.80 | 9.53 |
| 1000 | 42.16 | 24.10 | 11.40 |
| 1500 | 61.80 | 36.80 | 19.05 |
| B-7641 PermaSleeve™ LSZH Low Smoke Zero Halogen Wire Marking Sleeves | | | |
| 094 | 4.62 | 2.03 | 1.19 |
| 125 | 5.97 | 2.79 | 1.57 |
| 187 | 8.51 | 3.83 | 2.39 |
| 250 | 11.15 | 5.46 | 3.18 |
| 375 | 16.38 | 8.13 | 4.78 |
| 500 | 21.62 | 11.43 | 6.35 |
| 750 | 31.75 | 17.78 | 9.53 |
| 1000 | 42.16 | 24.13 | 12.70 |
| 1500 | 61.80 | 35.56 | 19.05 |
| 2000 | 80.39 | 48.26 | 25.40 |
| B-7642 PermaSleeve™ Polyolefin Wire Marking Sleeves | | | |
| 094 | 4.62 | 2.03 | 1.19 |
| 125 | 5.97 | 2.79 | 1.57 |
| 187 | 8.51 | 3.83 | 2.39 |
| 250 | 11.15 | 5.46 | 3.18 |
| 375 | 16.38 | 8.13 | 4.78 |
| 500 | 21.62 | 11.43 | 6.35 |
| 750 | 31.75 | 17.78 | 9.53 |
| 1000 | 42.16 | 24.13 | 12.70 |
| 1500 | 61.80 | 35.56 | 19.05 |
| 2000 | 80.39 | 48.26 | 25.40 |

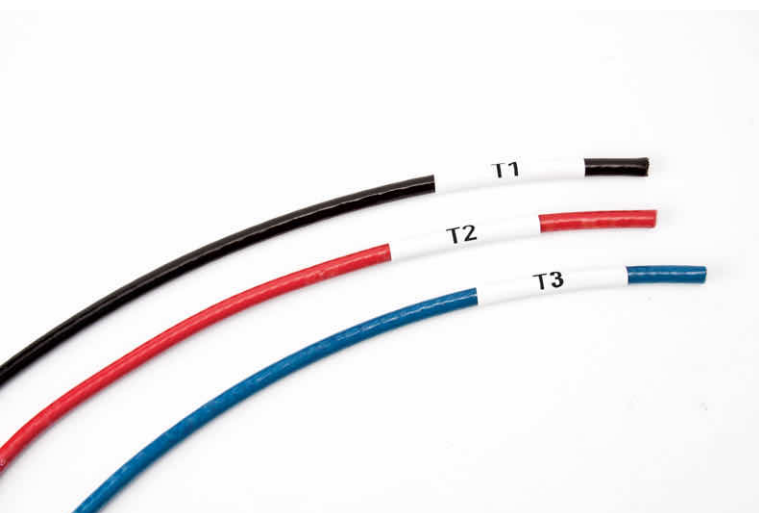

B-342 PermaSleeve PS polyolefin wire marking sleeves

Standard military/industrial grade. 3:1 Shrink ratio

- A 3:1 heat shrinkable wire marker sleeve that fits snugly around wires
- Can be used for identification or wire protection
- Fade-resistant and flame-retardant

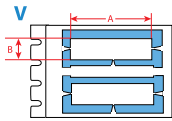

| Diagram | Order Reference | Colour | Label Width A (mm) | Label Height B (mm) | Vertical Repeat D (mm) | Labels per Roll | Printer Ribbon Series |
|-------------------------------|--------------------|--------|--------------------|---------------------|------------------------|-----------------|-----------------------|
| B-342: Heat-shrink Polyolefin | | | | | | | |
| V | B33-1000-2-342 | White | 50.80 | 42.16 | 50.80 | 250 | B30-R4300 |
| V | B33-1000-2-342YL | Yellow | 50.80 | 42.16 | 50.80 | 250 | B30-R4300 |
| V | B33-125-2-342 | White | 50.80 | 5.97 | 12.70 | 1000 | B30-R4300 |
| V | B33-125-2-342-2 | White | 25.40 | 5.97 | 12.70 | 2000 | B30-R4300 |
| V | B33-125-2-342YL | Yellow | 50.80 | 5.97 | 12.70 | 1000 | B30-R4300 |
| V | B33-125-2-342YL-2 | Yellow | 25.40 | 5.97 | 12.70 | 2000 | B30-R4300 |
| V | B33-1500-2-342 | White | 50.80 | 61.80 | 76.20 | 150 | B30-R4300 |
| V | B33-1500-2-342BK | Black | 50.80 | 61.80 | 76.20 | 150 | B30-R4500-SV |
| V | B33-1500-2-342YL | Yellow | 50.80 | 61.80 | 76.20 | 150 | B30-R4300 |
| V | B33-1500-2-342YL-2 | Yellow | 25.40 | 61.80 | 76.20 | 300 | B30-R4300 |
| V | B33-187-2-342 | White | 50.80 | 8.51 | 15.88 | 750 | B30-R4300 |
| V | B33-187-2-342-2 | White | 25.40 | 8.51 | 15.88 | 1500 | B30-R4300 |
| V | B33-187-2-342YL | Yellow | 50.80 | 8.51 | 15.88 | 750 | B30-R4300 |
| V | B33-250-2-342 | White | 50.80 | 11.15 | 19.05 | 500 | B30-R4300 |
| V | B33-250-2-342-2 | White | 25.40 | 11.15 | 19.05 | 1000 | B30-R4300 |
| V | B33-250-2-342YL | Yellow | 50.80 | 11.15 | 19.05 | 500 | B30-R4300 |
| V | B33-375-2-342 | White | 50.80 | 16.38 | 25.40 | 500 | B30-R4300 |
| V | B33-375-2-342-2 | White | 25.40 | 16.38 | 25.40 | 1000 | B30-R4300 |
| V | B33-375-2-342YL | Yellow | 50.80 | 16.38 | 25.40 | 500 | B30-R4300 |
| V | B33-500-2-342 | White | 50.80 | 21.62 | 31.75 | 350 | B30-R4300 |
| V | B33-500-2-342-2 | White | 25.40 | 21.62 | 31.75 | 700 | B30-R4300 |
| V | B33-500-2-342YL | Yellow | 50.80 | 21.62 | 31.75 | 350 | B30-R4300 |
| V | B33-500-2-342YL-2 | Yellow | 25.40 | 21.62 | 31.75 | 700 | B30-R4300 |
| V | B33-750-2-342 | White | 50.80 | 31.75 | 41.28 | 250 | B30-R4300 |
| V | B33-750-2-342YL | Yellow | 50.80 | 31.75 | 41.28 | 250 | B30-R4300 |
| V | B33-94-2-342 | White | 50.80 | 4.62 | 12.70 | 1000 | B30-R4300 |
| V | B33-94-2-342-2 | White | 25.40 | 4.62 | 12.70 | 2000 | B30-R4300 |
| V | B33-94-2-342YL | Yellow | 50.80 | 4.62 | 12.70 | 1000 | B30-R4300 |
| V | B33-94-2-342YL-2 | Yellow | 25.40 | 4.62 | 12.70 | 2000 | B30-R4300 |
| V | B33D-1000-2-342BK | Black | 50.80 | 42.16 | 50.80 | 250 | B30-R4500-SV |
| V | B33D-1000-2-342YL | Yellow | 50.80 | 42.16 | 50.80 | 250 | B30-R4300 |
| V | B33D-125-2-342 | White | 50.80 | 5.97 | 12.70 | 1000 | B30-R4300 |
| V | B33D-125-2-342BK | Black | 50.80 | 5.97 | 12.70 | 1000 | B30-R4500-SV |
| V | B33D-125-2-342YL | Yellow | 50.80 | 5.97 | 12.70 | 1000 | B30-R4300 |
| V | B33D-1500-2-342 | White | 50.80 | 61.80 | 76.20 | 150 | B30-R4300 |
| V | B33D-1500-2-342BK | Black | 50.80 | 61.80 | 76.20 | 150 | B30-R4500-SV |
| V | B33D-1500-2-342YL | Yellow | 50.80 | 61.80 | 76.20 | 150 | B30-R4300 |
| V | B33D-187-2-342 | White | 50.80 | 8.51 | 15.88 | 750 | B30-R4300 |
| V | B33D-187-2-342BK | Black | 50.80 | 8.51 | 15.88 | 750 | B30-R4500-SV |
| V | B33D-187-2-342YL | Yellow | 50.80 | 8.51 | 15.88 | 750 | B30-R4300 |
| V | B33D-250-2-342 | White | 50.80 | 11.15 | 19.05 | 500 | B30-R4300 |
| V | B33D-250-2-342YL | Yellow | 50.80 | 11.15 | 19.05 | 500 | B30-R4300 |
| V | B33D-375-2-342 | White | 50.80 | 16.38 | 25.40 | 500 | B30-R4300 |
| V | B33D-375-2-342YL | Yellow | 50.80 | 16.38 | 25.40 | 500 | B30-R4300 |
| V | B33D-500-2-342 | White | 50.80 | 21.62 | 31.75 | 350 | B30-R4300 |
| V | B33D-500-2-342YL | Yellow | 50.80 | 21.62 | 31.75 | 350 | B30-R4300 |
| V | B33D-750-2-342 | White | 50.80 | 31.75 | 41.28 | 250 | B30-R4300 |
| V | B33D-750-2-342BK | Black | 50.80 | 31.75 | 41.28 | 250 | B30-R4500-SV |
| V | B33D-750-2-342YL | Yellow | 50.80 | 31.75 | 41.28 | 250 | B30-R4300 |
| V | B33D-94-2-342 | White | 50.80 | 4.62 | 12.70 | 1000 | B30-R4300 |
| V | B33D-94-2-342BK | Black | 50.80 | 4.62 | 12.70 | 1000 | B30-R4500-SV |
| V | B33D-94-2-342YL | Yellow | 50.80 | 4.62 | 12.70 | 1000 | B30-R4300 |

B-7641 PermaSleeve low smoke zero halogen wire marking sleeves

Permanent heat shrink wire identification

- A 2:1 double-sided printable heat-shrink Polyolefin wire marker sleeve designed for wire identification and insulation purposes
- Contains no added halogens, offers excellent flame retardant characteristics combined with minimal smoke emission

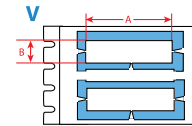

| Diagram | Order Reference | Colour | Label Width A (mm) | Label Height B (mm) | Vertical Repeat D (mm) | Labels per Roll | Printer Ribbon Series |
|--------------------------------|-------------------|--------|--------------------|---------------------|------------------------|-----------------|-----------------------|
| B-7641: Heat-shrink Polyolefin | | | | | | | |
| V | B33D-1000-2-7641Y | Yellow | 50.80 | 42.16 | 50.80 | 150 | B30-R6600 |
| V | B33D-125-2-7641 | White | 50.80 | 5.97 | 12.70 | 500 | B30-R6600 |
| V | B33D-125-2-7641Y | Yellow | 50.80 | 5.97 | 12.70 | 500 | B30-R6600 |
| V | B33D-1500-2-7641 | White | 50.80 | 61.80 | 76.20 | 50 | B30-R6600 |
| V | B33D-1500-2-7641Y | Yellow | 50.80 | 61.80 | 76.20 | 50 | B30-R6600 |
| V | B33D-187-2-7641 | White | 50.80 | 8.51 | 15.88 | 450 | B30-R6600 |
| V | B33D-187-2-7641Y | Yellow | 50.80 | 8.51 | 15.88 | 450 | B30-R6600 |
| V | B33D-250-2-7641 | White | 50.80 | 11.15 | 19.05 | 400 | B30-R6600 |
| V | B33D-250-2-7641Y | Yellow | 50.80 | 11.15 | 19.05 | 400 | B30-R6600 |
| V | B33D-375-2-7641 | White | 50.80 | 16.38 | 25.40 | 250 | B30-R6600 |
| V | B33D-375-2-7641Y | Yellow | 50.80 | 16.38 | 25.40 | 250 | B30-R6600 |
| V | B33D-500-2-7641 | White | 50.80 | 21.62 | 31.75 | 225 | B30-R6600 |
| V | B33D-500-2-7641Y | Yellow | 50.80 | 21.62 | 31.75 | 225 | B30-R6600 |
| V | B33D-750-2-7641Y | Yellow | 50.80 | 31.75 | 41.28 | 150 | B30-R6600 |
| V | B33D-94-2-7641 | White | 50.80 | 4.62 | 12.70 | 500 | B30-R6600 |

2-pass double-side sleeve printing with no wasted sleeves using i5300 printer and Brady Workstation

- Use double-sided sleeve module in Brady workstation
- Change text content, size and even rotation for each side!
- See a demo at Bradyeurope.com



QuickSleeve Handheld Sleeve Applicator (149474)



B-7642 PermaSleeve HX polyolefin wire marking sleeves

Military/Industrial grade. 2:1 Shrink ratio

- A 2:1 heat shrinkable wire marker sleeve that fits snugly around wires
- Flame-retardant and high-temp rated but not as high temp as B-345 "HT" Sleeves

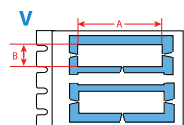

| Diagram | Order Reference | Colour | Label Width A (mm) | Label Height B (mm) | Vertical Repeat D (mm) | Labels per Roll | Printer Ribbon Series |
|--------------------------------|------------------|--------|--------------------|---------------------|------------------------|-----------------|-----------------------|
| B-7642: Heat-shrink Polyolefin | | | | | | | |
| V | B33-94-2-7642 | White | 50.80 | 4.62 | 12.70 | 500 | B30-R4300 |
| V | B33-125-2-7642 | White | 50.80 | 5.97 | 12.70 | 500 | B30-R4300 |
| V | B33-187-2-7642 | White | 50.80 | 8.51 | 15.88 | 450 | B30-R4300 |
| V | B33-250-2-7642 | White | 50.80 | 11.15 | 19.05 | 400 | B30-R4300 |
| V | B33-1000-2-7642 | White | 50.80 | 42.16 | 50.80 | 150 | B30-R4300 |
| V | B33-1500-2-7642 | White | 50.80 | 61.80 | 76.20 | 50 | B30-R4300 |
| V | B33D-94-2-7642 | White | 50.80 | 4.62 | 12.70 | 500 | B30-R4300 |
| V | B33D-125-2-7642 | White | 50.80 | 5.97 | 12.70 | 500 | B30-R4300 |
| V | B33D-250-2-7642 | White | 50.80 | 11.15 | 19.05 | 400 | B30-R4300 |
| V | B33D-375-2-7642 | White | 50.80 | 16.38 | 25.40 | 250 | B30-R4300 |
| V | B33D-500-2-7642 | White | 50.80 | 21.62 | 31.75 | 225 | B30-R4300 |
| V | B33D-750-2-7642 | White | 50.80 | 31.75 | 41.28 | 150 | B30-R4300 |
| V | B33D-1000-2-7642 | White | 50.80 | 42.16 | 50.80 | 150 | B30-R4300 |
| V | B33D-1500-2-7642 | White | 50.80 | 61.80 | 76.20 | 50 | B30-R4300 |

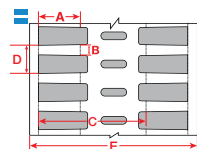

B-7697 Rigid DuraSleeve wire marking inserts

| Diagram | Order Reference | Colour | Label Width A (mm) | Label Height B (mm) | Vertical Repeat D (mm) | Labels per Roll | Printer Ribbon Series |
|-------------------|--------------------|--------|--------------------|---------------------|------------------------|-----------------|-----------------------|
| B-7697: Polyester | | | | | | | |
| ≡ | B33-10x4.4-7697-WT | White | 10.00 | 4.40 | 11.46 | 2500 | R4300 R6200 |
| ≡ | B33-12x4.4-7697-WT | White | 12.00 | 4.40 | 11.46 | 2500 | R4300 R6200 |
| ≡ | B33-16x4.4-7697-WT | White | 16.00 | 4.40 | 11.46 | 2500 | R4300 R6200 |
| ≡ | B33-23x4.4-7697-WT | White | 23.00 | 4.40 | 11.46 | 2500 | R4300 R6200 |
| ≡ | B33-30x4.4-7697-WT | White | 30.63 | 4.40 | 11.46 | 2500 | R4300 R6200 |



DuraSleeve tag carriers are produced in transparent PVC. The special shape of the carrier allows it to adapt to cables of various diameters. There are several sizes of carriers which cater for cables with external diameters from 1.30 mm up to 15 mm.

- Temperature range: -40 °C to 60 °C
- Material: PVC

Please contact your local Brady representative to identify and select the most appropriate carrier for your individual application.

Polyester labels

For general purpose industrial identification applications

- Widely used for PC board component identification, bin and shelf labels, barcoding and asset tracking
- 3 levels of adhesive strength



| Diagram | Order Reference | Colour | Label Width A (mm) | Label Height B (mm) | Label Length B (m) | Vertical Repeat D (mm) | Labels per Roll | Printer Ribbon Series |
|---|-----------------|-------------|-----------------------|------------------------|-----------------------|---------------------------|--------------------|--------------------------|
| B-422: Polyester | | | | | | | | |
| ● | B33-149-422 | White | 12.70 | 12.70 | - | 15.24 | 5000 | B30 Monocolour Series |
| ● | B33-5-422 | White | 25.40 | 12.70 | - | 15.24 | 5000 | B30 Monocolour Series |
| ▲ | B33-102-422 | White | 38.10 | 9.40 | - | 12.70 | 2500 | B30 Monocolour Series |
| ● | B33-147-422 | White | 38.10 | 9.53 | - | 12.70 | 2500 | B30 Monocolour Series |
| ▲ | B33-136-422 | White | 38.10 | 19.05 | - | 22.23 | 1500 | B30 Monocolour Series |
| ▲ | B33-17-422 | White | 50.80 | 25.40 | - | 28.58 | 1500 | B30 Monocolour Series |
| ▲ | B33-18-422 | White | 76.20 | 25.40 | - | 28.58 | 1500 | B30 Monocolour Series |
| ▲ | B33-19-422 | White | 76.20 | 50.80 | - | 53.98 | 500 | B30 Monocolour Series |
| ▲ | B33-76-422 | White | 101.60 | 76.20 | - | 79.38 | 500 | B30 Monocolour Series |
| ⊙ | B33C-312-422 | White | 7.92 | - | 25.91 | - | 1 | B30-R6000HF |
| ⊙ | B33C-375-422 | White | 9.53 | - | 25.91 | - | 1 | B30-R6000HF |
| B-423: Polyester | | | | | | | | |
| ● | B33-11-423 | White | 6.35 | 6.35 | - | 9.53 | 15000 | B30 Monocolour Series |
| ● | B33-38-423 | White | 9.53 | 9.53 | - | 12.07 | 5000 | B30 Monocolour Series |
| ● | B33-340-423 | White | 9.53 | 9.53 | - | 12.07 | 10000 | B30 Monocolour Series |
| ● | B33-149-423 | White | 12.70 | 12.70 | - | 15.24 | 5000 | B30 Monocolour Series |
| ▬ | B33-343-423 | White | 12.70 | 5.08 | - | 8.26 | 10000 | B30 Monocolour Series |
| ● | B33-1-423 | White | 19.05 | 6.35 | - | 8.89 | 5000 | B30 Monocolour Series |
| ▲ | B33-46-423 | White | 19.05 | 6.35 | - | 8.89 | 5000 | B30 Monocolour Series |
| ▲ | B33-49-423 | White | 22.86 | 6.35 | - | 8.89 | 5000 | B30 Monocolour Series |
| ▲ | B33-103-423 | White | 25.40 | 6.35 | - | 8.89 | 5000 | B30 Monocolour Series |
| ● | B33-3-423 | White | 25.40 | 9.53 | - | 12.07 | 5000 | B30 Monocolour Series |
| ● | B33-5-423 | White | 25.40 | 12.70 | - | 15.24 | 5000 | B30 Monocolour Series |
| ● | B33-29-423 | White | 31.75 | 9.53 | - | 12.07 | 5000 | B30 Monocolour Series |
| ▲ | B33-43-423 | White | 31.75 | 6.35 | - | 8.89 | 5000 | B30 Monocolour Series |
| ▲ | B33-45-423 | White | 38.10 | 6.35 | - | 8.89 | 5000 | B30 Monocolour Series |
| ▲ | B33-72-423 | White | 44.45 | 6.35 | - | 8.89 | 5000 | B30 Monocolour Series |
| ▲ | B33-53-423 | White | 50.80 | 12.70 | - | 15.24 | 2500 | B30 Monocolour Series |
| ▲ | B33-17-423 | White | 50.80 | 25.40 | - | 28.58 | 1500 | B30 Monocolour Series |
| ▲ | B33-7-423 | White | 69.85 | 31.75 | - | 34.93 | 1000 | B30 Monocolour Series |
| ▲ | B33-19-423 | White | 76.20 | 50.80 | - | 53.98 | 500 | B30 Monocolour Series |
| ▲ | B33-18-423 | White | 76.20 | 25.40 | - | 28.58 | 1500 | B30 Monocolour Series |
| ▲ | B33-20-423 | White | 76.20 | 127.00 | - | 130.18 | 350 | B30 Monocolour Series |
| ▲ | B33-55-423 | White | 101.60 | 50.80 | - | 53.98 | 750 | B30 Monocolour Series |
| ▲ | B33-76-423 | White | 101.60 | 76.20 | - | 79.38 | 500 | B30 Monocolour Series |
| ▲ | B33-161-423 | White | 101.60 | 101.60 | - | 104.78 | 450 | B30 Monocolour Series |
| ▲ | B33-25-423 | White | 101.60 | 152.40 | - | 155.58 | 300 | B30 Monocolour Series |
| ∞ | B30C-2000-423 | White | 50.80 | - | 30.48 | - | 1 | B30 Monocolour Series |
| ∞ | B30C-3000-423 | White | 76.20 | - | 30.48 | - | 1 | B30 Monocolour Series |
| ⊙ | B30C-4000-423 | White | 101.60 | - | 45.72 | - | 1 | B30-R6000HF |
| B-423/B-966B: Polyester with Polyester Overlaminat | | | | | | | | |
| ▲ | B33-22-423 | White | 31.75 | 19.05 | - | 28.58 | 2000 | B30 Monocolour Series |
| ▲ | B33-23-423 | White | 50.80 | 25.40 | - | 34.93 | 800 | B30 Monocolour Series |
| ▲ | B33-24-423 | White | 69.85 | 44.45 | - | 53.98 | 500 | B30 Monocolour Series |
| B-430: Polyester | | | | | | | | |
| ● | B33-5-430 | Transparent | 25.40 | 12.70 | - | 15.24 | 5000 | B30 Monocolour Series |
| ▲ | B33-17-430 | Transparent | 50.80 | 25.40 | - | 28.58 | 1500 | B30 Monocolour Series |
| ▲ | B33-18-430 | Transparent | 76.20 | 25.40 | - | 28.58 | 1500 | B30 Monocolour Series |
| ∞ | B33C-3000-430 | Transparent | 76.20 | - | 30.48 | - | 1 | |
| B-432: Polyester >> | | | | | | | | |
| ● | B33-149-432 | Transparent | 12.70 | 12.70 | - | 15.24 | 5000 | B30 Monocolour Series |
| ▲ | B33-17-432 | Transparent | 50.80 | 25.40 | - | 28.58 | 1500 | B30 Monocolour Series |
| ▲ | B33-18-432 | Transparent | 76.20 | 25.40 | - | 28.58 | 1500 | B30 Monocolour Series |
| ▲ | B33-19-432 | Transparent | 76.20 | 50.80 | - | 53.98 | 500 | B30 Monocolour Series |
| ⊙ | B30C-4000-432 | Transparent | 101.60 | - | 36.58 | - | 1 | B30-R6000HF |

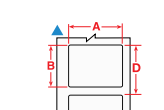
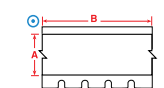
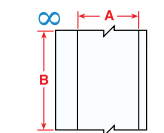
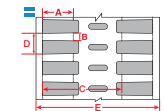
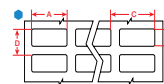



Polyester labels (Continued)

For general purpose industrial identification applications

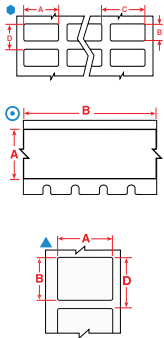

| Diagram | Order Reference | Colour | Label Width A (mm) | Label Height B (mm) | Label Length B (m) | Vertical Repeat D (mm) | Labels per Roll | Printer Ribbon Series |
|--------------------------|-----------------|--------|--------------------|---------------------|--------------------|------------------------|-----------------|-----------------------|
| B-483A: Polyester | | | | | | | | |
| ◆ | B33-149-483 | White | 12.70 | 12.70 | - | 15.24 | 5000 | B30 Monocolour Series |
| ◆ | B33-5-483 | White | 25.40 | 12.70 | - | 15.24 | 5000 | B30 Monocolour Series |
| ▲ | B33-17-483 | White | 50.80 | 25.40 | - | 28.58 | 1500 | B30 Monocolour Series |
| ▲ | B33-7-483 | White | 69.85 | 31.75 | - | 34.93 | 1000 | B30 Monocolour Series |
| ▲ | B33-19-483 | White | 76.20 | 50.80 | - | 53.98 | 500 | B30 Monocolour Series |
| ▲ | B33-18-483 | White | 76.20 | 25.40 | - | 28.58 | 1500 | B30 Monocolour Series |
| ▲ | B33-55-483 | White | 101.60 | 50.80 | - | 53.98 | 750 | B30 Monocolour Series |
| ▲ | B33-76-483 | White | 101.60 | 76.20 | - | 79.38 | 500 | B30 Monocolour Series |
| ◎ | B30C-4000-483 | White | 101.60 | - | 39.62 | - | 1 | B30-R6000HF |
| B-484A: Polyester | | | | | | | | |
| ▲ | B33-125-484 | White | 22.86 | 12.70 | - | 15.24 | 1500 | B30 Monocolour Series |
| ◆ | B33-5-484 | White | 25.40 | 12.70 | - | 15.24 | 5000 | B30 Monocolour Series |
| ▲ | B33-136-484 | White | 38.10 | 19.05 | - | 22.23 | 1500 | B30 Monocolour Series |
| ▲ | B33-17-484 | White | 50.80 | 25.40 | - | 28.58 | 1500 | B30 Monocolour Series |
| ▲ | B33-18-484 | White | 76.20 | 25.40 | - | 28.58 | 1500 | B30 Monocolour Series |
| ▲ | B33-19-484 | White | 76.20 | 50.80 | - | 53.98 | 500 | B30 Monocolour Series |
| ◎ | B30C-4000-484 | White | 101.60 | - | 45.72 | - | 1 | B30-R6000HF |
| B-488: Polyester | | | | | | | | |
| ◎ | B30C-4000-488 | White | 101.60 | - | 39.62 | - | 1 | B30-R4300 |
| B-489A: Polyester | | | | | | | | |
| ◆ | B33-5-489 | White | 25.40 | 12.70 | - | 15.24 | 5000 | B30 Monocolour Series |
| ▲ | B33-17-489 | White | 50.80 | 25.40 | - | 28.58 | 1500 | B30 Monocolour Series |
| ▲ | B33-19-489 | White | 76.20 | 50.80 | - | 53.98 | 500 | B30 Monocolour Series |
| ▲ | B33-18-489 | White | 76.20 | 25.40 | - | 28.58 | 1500 | B30 Monocolour Series |
| ◎ | B30C-4000-489 | White | 101.60 | - | 39.62 | - | 1 | B30-R4300 |
| B-618: Polyester | | | | | | | | |
| ◆ | B33-12-618 | White | 12.70 | 11.10 | - | 13.67 | 10000 | B30 Monocolour Series |
| ◆ | B33-5-618 | White | 25.40 | 12.70 | - | 15.24 | 7000 | B30 Monocolour Series |
| ◆ | B33-37-618 | White | 38.10 | 12.70 | - | 15.24 | 5000 | B30 Monocolour Series |
| ◆ | B33-6-618 | White | 38.10 | 19.05 | - | 22.23 | 3300 | B30 Monocolour Series |
| ◆ | B33-53-618 | White | 50.80 | 12.70 | - | 15.24 | 2500 | B30 Monocolour Series |
| ◆ | B33-17-618 | White | 50.80 | 25.40 | - | 28.58 | 1500 | B30 Monocolour Series |
| ◆ | B33-7-618 | White | 69.85 | 31.75 | - | 34.93 | 1000 | B30 Monocolour Series |
| ◆ | B33-18-618 | White | 76.20 | 25.40 | - | 28.58 | 1500 | B30 Monocolour Series |
| ◆ | B33-19-618 | White | 76.20 | 50.80 | - | 53.98 | 700 | B30 Monocolour Series |
| ◆ | B33-55-618 | White | 101.60 | 50.80 | - | 53.98 | 750 | B30 Monocolour Series |
| ◆ | B33-76-618 | White | 101.60 | 76.20 | - | 79.38 | 500 | B30 Monocolour Series |
| B-8423: Polyester | | | | | | | | |
| ◆ | B33-12-8423 | White | 12.70 | 11.10 | - | 14.13 | 2500 | B30-R6000HF |
| ◆ | B33-101-8423 | White | 19.05 | 6.35 | - | 9.40 | 2500 | B30-R6000HF |
| ◆ | B33-G2-8423YL | Yellow | 20.00 | 7.95 | - | 15.00 | 5000 | B30-R6000HF |
| ◆ | B33-13-8423 | White | 31.75 | 6.35 | - | 9.35 | 2500 | B30-R6000HF |
| ◆ | B33-104-8423 | White | 38.10 | 6.35 | - | 9.33 | 2500 | B30-R6000HF |
| ◆ | B33-600-8423 | White | 38.10 | 19.05 | - | 22.05 | 2500 | B30-R6000HF |
| B-8591: Polyester | | | | | | | | |
| ◆ | B33-37-8591-BK | Black | 38.10 | 12.70 | - | 15.24 | 4000 | B30 Monocolour Series |
| ◆ | B33-37-8591-SL | Silver | 38.10 | 12.70 | - | 15.24 | 4000 | B30 Monocolour Series |
| ◆ | B33-37-8591-WT | White | 38.10 | 12.70 | - | 15.24 | 4000 | B30 Monocolour Series |
| ◆ | B33-37-8591-YL | Yellow | 38.10 | 12.70 | - | 15.24 | 4000 | B30 Monocolour Series |
| ▲ | B33-53-8591-BK | Black | 50.80 | 12.70 | - | 15.24 | 2500 | B30 Monocolour Series |
| ▲ | B33-53-8591-SL | Silver | 50.80 | 12.70 | - | 15.24 | 2500 | B30 Monocolour Series |
| ▲ | B33-53-8591-WT | White | 50.80 | 12.70 | - | 15.24 | 2500 | B30 Monocolour Series |
| ▲ | B33-53-8591-YL | Yellow | 50.80 | 12.70 | - | 15.24 | 2500 | B30 Monocolour Series |
| ▲ | B33-7-8591-BK | Black | 69.85 | 31.75 | - | 34.93 | 1000 | B30 Monocolour Series |
| ▲ | B33-7-8591-SL | Silver | 69.85 | 31.75 | - | 34.93 | 1000 | B30 Monocolour Series |
| ▲ | B33-7-8591-WT | White | 69.85 | 31.75 | - | 34.93 | 1000 | B30 Monocolour Series |

Polyester labels (Continued)

For general purpose industrial identification applications

| Diagram | Order Reference | Colour | Label Width A (mm) | Label Height B (mm) | Label Length B (m) | Vertical Repeat D (mm) | Labels per Roll | Printer Ribbon Series |
|---------|-------------------|--------|--------------------|---------------------|--------------------|------------------------|-----------------|-----------------------|
| ▲ | B33-7-8591-YL | Yellow | 69.85 | 31.75 | - | 34.93 | 1000 | B30 Monocolour Series |
| ● | B33-76-8591-BK | Black | 101.60 | 76.20 | - | 79.38 | 400 | B30 Monocolour Series |
| ● | B33-76-8591-SL | Silver | 101.60 | 76.20 | - | 79.38 | 400 | B30 Monocolour Series |
| ● | B33-76-8591-WT | White | 101.60 | 76.20 | - | 79.38 | 400 | B30 Monocolour Series |
| ● | B33-76-8591-YL | Yellow | 101.60 | 76.20 | - | 79.38 | 400 | B30 Monocolour Series |
| ∞ | B33C-2000-8591-BK | Black | 50.80 | - | 30.48 | - | 1 | B30 Monocolour Series |
| ∞ | B33C-2000-8591-SL | Silver | 50.80 | - | 30.48 | - | 1 | B30 Monocolour Series |
| ∞ | B33C-2000-8591-WT | White | 50.80 | - | 30.48 | - | 1 | B30 Monocolour Series |
| ∞ | B33C-2000-8591-YL | Yellow | 50.80 | - | 30.48 | - | 1 | B30 Monocolour Series |
| ∞ | B33C-3000-8591-BK | Black | 76.20 | - | 30.48 | - | 1 | B30 Monocolour Series |
| ∞ | B33C-3000-8591-SL | Silver | 76.20 | - | 30.48 | - | 1 | B30 Monocolour Series |
| ∞ | B33C-3000-8591-WT | White | 76.20 | - | 30.48 | - | 1 | B30 Monocolour Series |
| ∞ | B33C-3000-8591-YL | Yellow | 76.20 | - | 30.48 | - | 1 | B30 Monocolour Series |
| ∞ | B33C-4000-8591-BK | Black | 101.60 | - | 30.48 | - | 1 | B30 Monocolour Series |
| ∞ | B33C-4000-8591-SL | Silver | 101.60 | - | 30.48 | - | 1 | B30 Monocolour Series |
| ∞ | B33C-4000-8591-WT | White | 101.60 | - | 30.48 | - | 1 | B30 Monocolour Series |
| ∞ | B33C-4000-8591-YL | Yellow | 101.60 | - | 30.48 | - | 1 | B30 Monocolour Series |

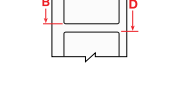
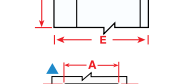
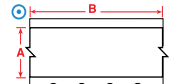
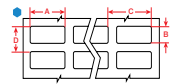

Metallised polyester labels

For product labelling, asset tracking and general industrial identification

- Silver metallic label withstands solvents and variable temperatures
- Ideal for serial number plates and rating plates with nameplate quality and metal looking finish

| Diagram | Order Reference | Colour | Label Width A (mm) | Label Height B (mm) | Label Length B (m) | Vertical Repeat D (mm) | Labels per Roll | Printer Ribbon Series |
|---|-----------------|------------|--------------------|---------------------|--------------------|------------------------|-----------------|-----------------------|
| B-413: Metallic, Non-metal Polyester | | | | | | | | |
| ● | B33-5-413 | Silver | 25.40 | 12.70 | - | 15.24 | 7000 | B30 Monocolour Series |
| ● | B33-37-413 | Silver | 38.10 | 12.70 | - | 15.24 | 5000 | B30 Monocolour Series |
| ● | B33-6-413 | Silver | 38.10 | 19.05 | - | 22.23 | 3300 | B30 Monocolour Series |
| ▲ | B33-17-413 | Silver | 50.80 | 25.40 | - | 28.58 | 1500 | B30 Monocolour Series |
| ▲ | B33-53-413 | Silver | 50.80 | 12.70 | - | 15.24 | 2500 | B30 Monocolour Series |
| ▲ | B33-7-413 | Silver | 69.85 | 31.75 | - | 34.93 | 1000 | B30 Monocolour Series |
| ▲ | B33-18-413 | Silver | 76.20 | 25.40 | - | 28.58 | 1500 | B30 Monocolour Series |
| ▲ | B33-19-413 | Silver | 76.20 | 50.80 | - | 53.98 | 700 | B30 Monocolour Series |
| ▲ | B33-55-413 | Silver | 101.60 | 50.80 | - | 53.98 | 750 | B30 Monocolour Series |
| ∞ | B33C-2000-413 | Silver | 50.80 | - | 30.48 | - | 1 | B30 Monocolour Series |
| ∞ | B33C-3000-413 | Silver | 76.20 | - | 30.48 | - | 1 | B30 Monocolour Series |
| ∞ | B33C-4000-413 | Silver | 101.60 | - | 30.48 | - | 1 | B30 Monocolour Series |
| B-428: Metallised Polyester | | | | | | | | |
| ● | B33-616-428 | Light Grey | 22.86 | 19.05 | - | 22.05 | 3000 | B30-R4300 |
| ● | B33-5-428 | Light Grey | 25.40 | 12.70 | - | 15.24 | 5000 | B30 Monocolour Series |
| ● | B33-37-428 | Light Grey | 38.10 | 12.70 | - | 15.24 | 4000 | B30 Monocolour Series |
| ● | B33-6-428 | Light Grey | 38.10 | 19.05 | - | 22.23 | 3000 | B30 Monocolour Series |
| ▲ | B33-53-428 | Light Grey | 50.80 | 12.70 | - | 15.24 | 2500 | B30 Monocolour Series |
| ▲ | B33-17-428 | Light Grey | 50.80 | 25.40 | - | 28.58 | 1500 | B30 Monocolour Series |
| ▲ | B33-7-428 | Light Grey | 69.85 | 31.75 | - | 34.93 | 1000 | B30 Monocolour Series |
| ▲ | B33-19-428 | Light Grey | 76.20 | 50.80 | - | 53.98 | 500 | B30 Monocolour Series |
| ▲ | B33-18-428 | Light Grey | 76.20 | 25.40 | - | 28.58 | 1500 | B30 Monocolour Series |
| ▲ | B33-55-428 | Light Grey | 101.60 | 50.80 | - | 53.98 | 500 | B30 Monocolour Series |
| ▲ | B33-161-428 | Light Grey | 101.60 | 101.60 | - | 104.78 | 300 | B30 Monocolour Series |
| ∞ | B30C-2000-428 | Light Grey | 50.80 | - | 30.48 | - | 1 | B30 Monocolour Series |
| ⊙ | B30C-4000-428 | Light Grey | 101.60 | - | 39.62 | - | 1 | B30-R4300 |
| B-428/B-966B: Metallised Polyester with Polyester Overlaminate | | | | | | | | |
| ● | B33-22-428 | Light Grey | 31.75 | 19.05 | - | 28.58 | 1700 | B30 Monocolour Series |
| ▲ | B33-23-428 | Light Grey | 50.80 | 25.40 | - | 34.93 | 700 | B30 Monocolour Series |
| ▲ | B33-24-428 | Light Grey | 69.85 | 44.45 | - | 53.98 | 450 | B30 Monocolour Series |
| B-434A: Metallised Polyester | | | | | | | | |
| ● | B33-5-434 | Silver | 25.40 | 12.70 | - | 15.24 | 5000 | B30 Monocolour Series |
| ▲ | B33-136-434 | Silver | 38.10 | 19.05 | - | 22.23 | 1500 | B30 Monocolour Series |
| ● | B33-37-434 | Silver | 38.10 | 12.70 | - | 15.24 | 5000 | B30 Monocolour Series |

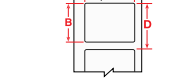
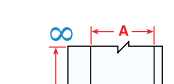
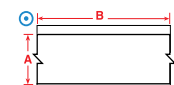
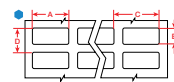

>>

Metallised polyester labels (Continued)

For product labelling, asset tracking and general industrial identification

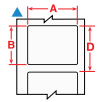
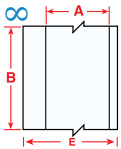
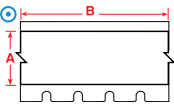
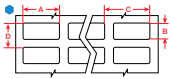
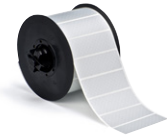

| Diagram | Order Reference | Colour | Label Width A (mm) | Label Height B (mm) | Label Length B (m) | Vertical Repeat D (mm) | Labels per Roll | Printer Ribbon Series |
|---|------------------|------------|--------------------|---------------------|--------------------|------------------------|-----------------|-----------------------|
| | B33-6-434 | Silver | 38.10 | 19.05 | - | 22.23 | 3300 | B30 Monocolour Series |
| | B33-17-434 | Silver | 50.80 | 25.40 | - | 28.58 | 1500 | B30 Monocolour Series |
| | B33-53-434 | Silver | 50.80 | 12.70 | - | 15.24 | 2500 | B30 Monocolour Series |
| | B33-7-434 | Silver | 69.85 | 31.75 | - | 34.93 | 1000 | B30 Monocolour Series |
| | B33-18-434 | Silver | 76.20 | 25.40 | - | 28.58 | 1500 | B30 Monocolour Series |
| | B33-19-434 | Silver | 76.20 | 50.80 | - | 53.98 | 500 | B30 Monocolour Series |
| | B33-55-434 | Silver | 101.60 | 50.80 | - | 53.98 | 750 | B30 Monocolour Series |
| | B33-161-434 | Silver | 101.60 | 101.60 | - | 104.78 | 350 | B30 Monocolour Series |
| | B30C-2000-434 | Silver | 50.80 | - | 30.48 | - | 1 | B30 Monocolour Series |
| | B30C-3000-434 | Silver | 76.20 | - | 30.48 | - | 1 | B30 Monocolour Series |
| | B30C-4000-434 | Silver | 101.60 | - | 39.62 | - | 1 | B30-R6000HF |
| B-435A: Metallised Polyester | | | | | | | | |
| | B33-5-435 | Silver | 25.40 | 12.70 | - | 15.24 | 7000 | B30 Monocolour Series |
| | B33-37-435 | Silver | 38.10 | 12.70 | - | 15.24 | 5000 | B30 Monocolour Series |
| | B33-6-435 | Silver | 38.10 | 19.05 | - | 22.23 | 3300 | B30 Monocolour Series |
| | B33-53-435 | Silver | 50.80 | 12.70 | - | 15.24 | 2500 | B30 Monocolour Series |
| | B33-17-435 | Silver | 50.80 | 25.40 | - | 28.58 | 1500 | B30 Monocolour Series |
| | B33-7-435 | Silver | 69.85 | 31.75 | - | 34.93 | 1000 | B30 Monocolour Series |
| | B33-18-435 | Silver | 76.20 | 25.40 | - | 28.58 | 1500 | B30 Monocolour Series |
| | B33-19-435 | Silver | 76.20 | 50.80 | - | 53.98 | 500 | B30 Monocolour Series |
| | B33-55-435 | Silver | 101.60 | 50.80 | - | 53.98 | 750 | B30 Monocolour Series |
| | B33-161-435 | Silver | 101.60 | 101.60 | - | 104.78 | 350 | B30 Monocolour Series |
| | B33C-2000-435 | Silver | 50.80 | - | 30.48 | - | 1 | B30 Monocolour Series |
| | B33C-3000-435 | Silver | 76.20 | - | 30.48 | - | 1 | B30 Monocolour Series |
| B-438: Tamper-evident Metallised Polyester | | | | | | | | |
| | B33-5-438 | Silver | 25.40 | 12.70 | - | 15.24 | 7000 | B30 Monocolour Series |
| | B33-37-438 | Silver | 38.10 | 12.70 | - | 15.24 | 5000 | B30 Monocolour Series |
| | B33-6-438 | Silver | 38.10 | 19.05 | - | 22.23 | 3300 | B30 Monocolour Series |
| | B30-17-438 | Silver | 50.80 | 25.40 | - | 28.58 | 1225 | B30 Monocolour Series |
| | B33-53-438 | Silver | 50.80 | 12.70 | - | 15.24 | 2500 | B30 Monocolour Series |
| | B33-7-438 | Silver | 69.85 | 31.75 | - | 34.93 | 1000 | B30 Monocolour Series |
| | B30-18-438 | Silver | 76.20 | 25.40 | - | 31.75 | 1225 | B30 Monocolour Series |
| | B30-222-438 | Silver | 76.20 | 50.80 | - | 57.15 | 650 | B30 Monocolour Series |
| | B33-55-438 | Silver | 101.60 | 50.80 | - | 53.98 | 750 | B30 Monocolour Series |
| | B33-76-438 | Silver | 101.60 | 76.20 | - | 79.38 | 500 | B30 Monocolour Series |
| | B30C-3000-438 | Silver | 76.20 | - | 30.48 | - | 1 | B30-R4300 |
| B-480A: Metallic, Non-metal Polyester | | | | | | | | |
| | B30C-4000-480 | Light Grey | 101.60 | - | 35.05 | - | 1 | B30-R6000HF |
| B-486B: Metallised Polyester | | | | | | | | |
| | B33-59-486 | Light Grey | 25.40 | 12.70 | - | 15.24 | 2500 | B30 Monocolour Series |
| | B33-53-486 | Light Grey | 50.80 | 12.70 | - | 15.24 | 2500 | B30 Monocolour Series |
| | B33-17-486 | Light Grey | 50.80 | 25.40 | - | 28.58 | 1300 | B30 Monocolour Series |
| | B33-7-486 | Light Grey | 69.85 | 31.75 | - | 34.93 | 1000 | B30 Monocolour Series |
| | B33-19-486 | Light Grey | 76.20 | 50.80 | - | 53.98 | 500 | B30 Monocolour Series |
| | B33-18-486 | Light Grey | 76.20 | 25.40 | - | 28.58 | 1300 | B30 Monocolour Series |
| | B33-161-486 | Light Grey | 101.60 | 101.60 | - | 104.78 | 250 | B30 Monocolour Series |
| | B30C-4000-486 | Light Grey | 101.60 | - | 35.05 | - | 1 | B30-R4300 |
| B-565: Metallised Polyester | | | | | | | | |
| | B30C-1125-565-SL | Silver | 28.58 | - | 30.48 | - | 1 | B30-R10000 |
| | B30C-2250-565-SL | Silver | 57.15 | - | 30.48 | - | 1 | B30-R10000 |
| | B30C-4000-565-SL | Silver | 101.60 | - | 30.48 | - | 1 | B30-R10000 |
| B-7563: Metallised Polyester | | | | | | | | |
| | B33-600-7563 | Silver | 38.10 | 19.05 | - | 22.05 | 2500 | B30-R6000HF |
| | B30-135-7563 | Silver | 38.10 | 19.05 | - | 22.22 | 3154 | B30-R6000HF |
| | B30-17-7563 | Silver | 50.80 | 25.40 | - | 28.58 | 1226 | B30-R6000HF |
| | B30-7-7563 | Silver | 69.85 | 31.75 | - | 34.93 | 1003 | B30-R6000HF |
| | B30-222-7563 | Silver | 76.20 | 50.80 | - | 57.15 | 649 | B30-R6000HF |

B-424 Paper labels

Economical choice for light duty general identification

- White finish and matt topcoat
- Excellent contrast and smear resistance for barcode printing



| Diagram | Order Reference | Colour | Label Width A (mm) | Label Height B (mm) | Label Length B (m) | Vertical Repeat D (mm) | Labels per Roll | Printer Ribbon Series |
|--------------|-----------------|--------|--------------------|---------------------|--------------------|------------------------|-----------------|-----------------------|
| B-424: Paper | | | | | | | | |
| ▲ | B33-53-424 | White | 50.80 | 12.70 | - | 15.24 | 2500 | B30 Monocolour Series |
| ▲ | B33-17-424 | White | 50.80 | 25.40 | - | 28.58 | 1500 | B30 Monocolour Series |
| ▲ | B33-7-424 | White | 69.85 | 31.75 | - | 34.93 | 1000 | B30 Monocolour Series |
| ▲ | B33-20-424 | White | 76.20 | 127.00 | - | 130.18 | 250 | B30 Monocolour Series |
| ▲ | B33-19-424 | White | 76.20 | 50.80 | - | 53.98 | 500 | B30 Monocolour Series |
| ▲ | B33-18-424 | White | 76.20 | 25.40 | - | 28.58 | 1500 | B30 Monocolour Series |
| ▲ | B33-55-424 | White | 101.60 | 50.80 | - | 53.98 | 750 | B30 Monocolour Series |
| ▲ | B33-25-424 | White | 152.40 | 101.60 | - | 155.58 | 350 | B30 Monocolour Series |
| ⊙ | B30C-4000-424 | White | 101.60 | - | 45.72 | - | 1 | B30-R4300 |

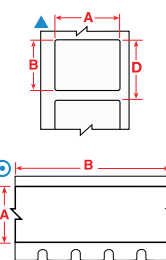

B-425 Polypropylene labels

General labelling material for indoor use

- Outstanding chemical and solvent resistance and print performance
- Not recommended for prolonged outdoor use (use B-595 indoor/outdoor vinyl for 8-10 year outdoor use)

| Diagram | Order Reference | Colour | Label Width A (mm) | Label Height B (mm) | Vertical Repeat D (mm) | Labels per Roll | Printer Ribbon Series |
|-----------------------|-----------------|--------|--------------------|---------------------|------------------------|-----------------|-----------------------|
| B-425A: Polypropylene | | | | | | | |
| ● | B33-5-425 | White | 25.40 | 12.70 | 15.24 | 5000 | B30 Monocolour Series |
| ▲ | B33-17-425 | White | 50.80 | 25.40 | 28.58 | 1500 | B30 Monocolour Series |
| ▲ | B33-18-425 | White | 76.20 | 25.40 | 28.58 | 1500 | B30 Monocolour Series |
| ▲ | B33-19-425 | White | 76.20 | 50.80 | 53.98 | 500 | B30 Monocolour Series |

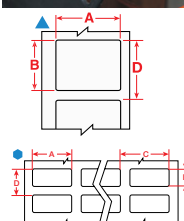

B-439 General identification vinyl labels

High Adhesion

- Designed for use in ambient conditions with limited solvent exposure
- Indoor/outdoor vinyl film has an acrylic pressure sensitive adhesive
- Service temperature of -70 to 40° C
- Available in many different colours as a custom option

| Diagram | Order Reference | Colour | Label Width A (mm) | Label Height B (mm) | Vertical Repeat D (mm) | Labels per Roll | Printer Ribbon Series |
|--------------|-----------------|--------|--------------------|---------------------|------------------------|-----------------|-----------------------|
| B-439: Vinyl | | | | | | | |
| ● | B33-5-439 | White | 25.40 | 12.70 | 15.24 | 7000 | B30 Monocolour Series |
| ▲ | B33-37-439 | White | 38.10 | 12.70 | 15.24 | 5000 | B30 Monocolour Series |
| ▲ | B33-17-439 | White | 50.80 | 25.40 | 28.58 | 1000 | B30 Monocolour Series |
| ▲ | B33-53-439 | White | 50.80 | 12.70 | 15.24 | 2500 | B30 Monocolour Series |
| ▲ | B33-18-439 | White | 76.20 | 25.40 | 28.58 | 1000 | B30 Monocolour Series |
| ▲ | B33-19-439 | White | 76.20 | 50.80 | 53.98 | 700 | B30 Monocolour Series |
| ▲ | B33-55-439 | White | 101.60 | 50.80 | 53.98 | 700 | B30 Monocolour Series |
| ▲ | B33-76-439 | White | 101.60 | 76.20 | 79.38 | 500 | B30 Monocolour Series |

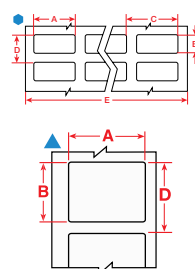

B-595 Outdoor grade vinyl labels

For 8-10 year outdoor use

- Semi-gloss finish
- Good chemical, moisture, UV and weather resistance
- Highly pliable material conforms to rough and curved surfaces and equipment
- Average outdoor durability of the label is 8-10 years depending on the placement



| Diagram | Order Reference | Colour | Label Width A (mm) | Label Height B (mm) | Vertical Repeat D (mm) | Labels per Roll | Printer Ribbon Series |
|--------------|--------------------|--------|--------------------|---------------------|------------------------|-----------------|-----------------------|
| B-595: Vinyl | | | | | | | |
| ▲ | B30-242-595-BLNKWT | White | 28.58 | 72.39 | 82.55 | 300 | B30-R10000 |
| ▲ | B30-241-595-BLNKWT | White | 76.20 | 57.15 | 82.55 | 300 | B30-R10000 |
| ▲ | B30-241-595-BLNKYL | Yellow | 76.20 | 57.15 | 82.55 | 300 | B30-R10000 |
| ▲ | B30-219-595-BLNKWT | White | 97.79 | 57.15 | 107.95 | 250 | B30-R10000 |
| ▲ | B30-25-595-BLNKWT | White | 152.40 | 101.60 | 158.75 | 175 | B30-R10000 |
| ▲ | B30-25-595-BLNKYL | Yellow | 152.40 | 101.60 | 158.75 | 175 | B30-R10000 |

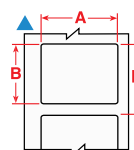



B-717, B-718 and B-719 Static dissipative polyimide labels

For printed circuit board and electronic component identification

- Static dissipative adhesive and release liner with surface resistivity values
- Complies with EIA-541 Packaging Material Standards for ESD sensitive items
- Withstands the various processes, fluxes and cleaning solvents encountered in the manufacture of PC Boards
- For use on top or bottom-sided component identification or board identification

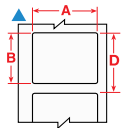
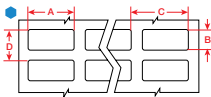

| Diagram | Order Reference | Colour | Label Width A (mm) | Label Height B (mm) | Vertical Repeat D (mm) | Labels per Roll | Printer Ribbon Series |
|-------------------------|-----------------|--------|--------------------|---------------------|------------------------|-----------------|-----------------------|
| B-717: Polyimide | | | | | | | |
| ▲ | B33-46-717 | White | 6.35 | 19.05 | 8.89 | 5000 | B30 Monocolour Series |
| ● | B33-70-717 | White | 6.35 | 6.35 | 8.89 | 20000 | B30 Monocolour Series |
| ● | B33-340-717 | White | 9.53 | 9.53 | 12.07 | 10000 | B30 Monocolour Series |
| ● | B33-12-717 | White | 12.70 | 11.10 | 13.64 | 10000 | B30 Monocolour Series |
| ▲ | B33-341-717 | White | 16.51 | 5.08 | 8.26 | 10000 | B30 Monocolour Series |
| ● | B33-1-717 | White | 19.05 | 6.35 | 8.89 | 10000 | B30 Monocolour Series |
| ● | B33-2-717 | White | 22.86 | 6.35 | 8.89 | 10000 | B30 Monocolour Series |
| ▲ | B33-103-717 | White | 25.40 | 6.35 | 8.89 | 5000 | B30 Monocolour Series |
| ● | B33-51-717 | White | 25.40 | 6.35 | 8.89 | 10000 | B30 Monocolour Series |
| ▲ | B33-43-717 | White | 31.75 | 6.35 | 8.89 | 5000 | B30 Monocolour Series |
| ● | B33-13-717 | White | 31.75 | 6.35 | 9.53 | 7000 | B30 Monocolour Series |
| ▲ | B33-45-717 | White | 38.10 | 6.35 | 8.89 | 5000 | B30 Monocolour Series |
| ● | B33-4-717 | White | 38.10 | 6.35 | 8.89 | 8000 | B30 Monocolour Series |
| B-718: Polyimide | | | | | | | |
| ● | B33-11-718 | White | 6.35 | 6.35 | 9.53 | 15000 | B30 Monocolour Series |
| ▲ | B33-46-718 | White | 6.35 | 19.05 | 8.89 | 5000 | B30 Monocolour Series |
| ● | B33-38-718 | White | 9.53 | 9.53 | 12.07 | 5000 | B30 Monocolour Series |
| ● | B33-340-718 | White | 9.53 | 9.53 | 12.07 | 10000 | B30 Monocolour Series |
| ● | B33-12-718 | White | 12.70 | 11.10 | 13.64 | 10000 | B30 Monocolour Series |
| ● | B33-341-718 | White | 16.51 | 5.08 | 8.26 | 10000 | B30 Monocolour Series |
| ● | B33-1-718 | White | 19.05 | 6.35 | 8.89 | 5000 | B30 Monocolour Series |
| ▲ | B33-49-718 | White | 22.86 | 6.35 | 8.89 | 5000 | B30 Monocolour Series |
| ● | B33-2-718 | White | 22.86 | 6.35 | 8.89 | 10000 | B30 Monocolour Series |
| ● | B33-51-718 | White | 25.40 | 6.35 | 8.89 | 10000 | B30 Monocolour Series |
| ▲ | B33-103-718 | White | 25.40 | 6.35 | 8.89 | 4000 | B30 Monocolour Series |
| ● | B33-3-718 | White | 25.40 | 9.53 | 12.07 | 10000 | B30 Monocolour Series |
| ● | B33-5-718 | White | 25.40 | 12.70 | 15.24 | 10000 | B30 Monocolour Series |
| ● | B33-13-718 | White | 31.75 | 6.35 | 9.53 | 7000 | B30 Monocolour Series |
| ▲ | B33-45-718 | White | 38.10 | 6.35 | 8.89 | 5000 | B30 Monocolour Series |
| ● | B33-4-718 | White | 38.10 | 6.35 | 8.89 | 8000 | B30 Monocolour Series |
| ▲ | B33-72-718 | White | 44.45 | 6.35 | 8.89 | 5000 | B30 Monocolour Series |
| ▲ | B33-15-718 | White | 50.80 | 6.35 | 9.53 | 3200 | B30 Monocolour Series |
| B-719: Polyimide | | | | | | | |
| ▲ | B33-46-719 | White | 6.35 | 19.05 | 8.89 | 5000 | B30 Monocolour Series |
| ● | B33-70-719 | White | 6.35 | 6.35 | 8.89 | 20000 | B30 Monocolour Series |
| ● | B33-38-719 | White | 9.53 | 9.53 | 12.07 | 5000 | B30 Monocolour Series |
| ● | B33-340-719 | White | 9.53 | 9.53 | 12.07 | 10000 | B30 Monocolour Series |
| ● | B33-12-719 | White | 12.70 | 11.10 | 13.64 | 10000 | B30 Monocolour Series |
| ● | B33-341-719 | White | 16.51 | 5.08 | 8.26 | 10000 | B30 Monocolour Series |
| ● | B33-1-719 | White | 19.05 | 6.35 | 8.89 | 10000 | B30 Monocolour Series |
| ● | B33-2-719 | White | 22.86 | 6.35 | 8.89 | 5000 | B30 Monocolour Series |
| ● | B33-51-719 | White | 25.40 | 6.35 | 8.89 | 10000 | B30 Monocolour Series |
| ▲ | B33-103-719 | White | 25.40 | 6.35 | 8.89 | 4000 | B30 Monocolour Series |
| ● | B33-5-719 | White | 25.40 | 12.70 | 15.24 | 7000 | B30 Monocolour Series |
| ▲ | B33-43-719 | White | 31.75 | 6.35 | 8.89 | 5000 | B30 Monocolour Series |
| ● | B33-13-719 | White | 31.75 | 6.35 | 9.53 | 7000 | B30 Monocolour Series |
| ● | B33-4-719 | White | 38.10 | 6.35 | 8.89 | 8000 | B30 Monocolour Series |

B-8423 Polyester labels

For circuit board and component identification

- SMT - Top/Bottom; Through Hole - Bottom; Through Hole - Top

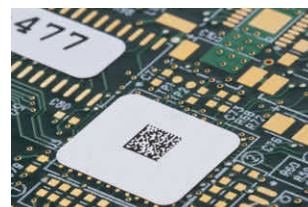
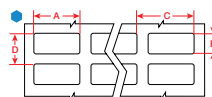

| Diagram | Order Reference | Colour | Label Width A (mm) | Label Height B (mm) | Vertical Repeat D (mm) | Labels per Roll | Printer Ribbon Series |
|-------------------|-----------------|--------|--------------------|---------------------|------------------------|-----------------|-----------------------|
| B-8423: Polyester | | | | | | | |
| ● | B33-12-8423 | White | 12.70 | 11.10 | 14.13 | 2500 | B30-R6000HF |
| ● | B33-101-8423 | White | 19.05 | 6.35 | 9.40 | 2500 | B30-R6000HF |
| ● | B33-G2-8423YL | Yellow | 20.00 | 7.95 | 15.00 | 5000 | B30-R6000HF |
| ● | B33-13-8423 | White | 31.75 | 6.35 | 9.35 | 2500 | B30-R6000HF |
| ● | B33-104-8423 | White | 38.10 | 6.35 | 9.33 | 2500 | B30-R6000HF |

B-724 and B-727 Standard polyimide labels

For circuit board labels and high-temperature general identification applications

- Withstands the various processes, fluxes and cleaning solvents encountered in the manufacture of printed circuit boards
- For use on top bottom-side component identification or board identification
- 2 temperature levels to meet your needs

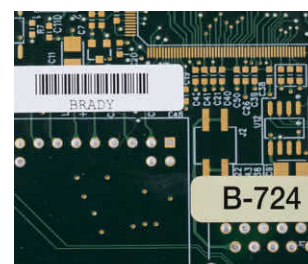

| Diagram | Order Reference | Colour | Label Width A (mm) | Label Height B (mm) | Label Length B (m) | Vertical Repeat D (mm) | Labels per Roll | Printer Ribbon Series |
|------------------|-----------------|--------|--------------------|---------------------|--------------------|------------------------|-----------------|-----------------------|
| B-724: Polyimide | | | | | | | | |
| ▲ | B33-46-724 | Amber | 6.35 | 19.05 | - | 8.89 | 5000 | B30 Monocolour Series |
| ● | B33-340-724 | Amber | 9.53 | 9.53 | - | 12.07 | 10000 | B30 Monocolour Series |
| ▲ | B33-344-724 | Amber | 12.70 | 5.08 | - | 8.26 | 3700 | B30 Monocolour Series |
| ● | B33-12-724 | Amber | 12.70 | 11.10 | - | 13.64 | 10000 | B30 Monocolour Series |
| ● | B33-341-724 | Amber | 16.51 | 5.08 | - | 8.26 | 10000 | B30 Monocolour Series |
| ▲ | B33-342-724 | Amber | 16.51 | 5.08 | - | 8.26 | 3700 | B30 Monocolour Series |
| ● | B33-1-724 | Amber | 19.05 | 6.35 | - | 8.89 | 5000 | B30 Monocolour Series |
| ● | B33-2-724 | Amber | 22.86 | 6.35 | - | 8.89 | 5000 | B30 Monocolour Series |
| ● | B33-51-724 | Amber | 25.40 | 6.35 | - | 8.89 | 10000 | B30 Monocolour Series |
| ▲ | B33-103-724 | Amber | 25.40 | 6.35 | - | 8.89 | 4000 | B30 Monocolour Series |
| ● | B33-5-724 | Amber | 25.40 | 12.70 | - | 15.24 | 7000 | B30 Monocolour Series |
| ● | B33-13-724 | Amber | 31.75 | 6.35 | - | 9.53 | 7000 | B30 Monocolour Series |
| ● | B33-4-724 | Amber | 38.10 | 6.35 | - | 8.89 | 5000 | B30 Monocolour Series |
| ◎ | B30C-4000-724 | Amber | 101.60 | - | 39.62 | - | 1 | B30-R4300 |
| B-727: Polyimide | | | | | | | | |
| ● | B33-11-727 | White | 6.35 | 6.35 | - | 9.53 | 5000 | B30 Monocolour Series |
| ● | B33-70-727 | White | 6.35 | 6.35 | - | 8.89 | 20000 | B30 Monocolour Series |
| ● | B33-71-727 | White | 8.00 | 8.00 | - | 11.43 | 20000 | B30 Monocolour Series |
| ● | B33-38-727 | White | 9.53 | 9.53 | - | 12.07 | 5000 | B30 Monocolour Series |
| ● | B33-340-727 | White | 9.53 | 9.53 | - | 12.07 | 10000 | B30 Monocolour Series |
| ● | B33-12-727 | White | 12.70 | 11.10 | - | 13.64 | 10000 | B30 Monocolour Series |
| ● | B33-341-727 | White | 16.51 | 5.08 | - | 8.26 | 10000 | B30 Monocolour Series |
| ▲ | B33-342-727 | White | 16.51 | 5.08 | - | 8.26 | 3700 | B30 Monocolour Series |
| ● | B33-1-727 | White | 19.05 | 6.35 | - | 8.89 | 5000 | B30 Monocolour Series |
| ● | B33-2-727 | White | 22.86 | 6.35 | - | 8.89 | 5000 | B30 Monocolour Series |
| ▲ | B33-49-727 | White | 22.86 | 6.35 | - | 8.89 | 5000 | B30 Monocolour Series |
| ▲ | B33-103-727 | White | 25.40 | 6.35 | - | 8.89 | 5000 | B30 Monocolour Series |
| ▲ | B33-58-727 | White | 25.40 | 9.53 | - | 12.07 | 4000 | B30 Monocolour Series |
| ▲ | B33-59-727 | White | 25.40 | 12.70 | - | 15.24 | 2500 | B30 Monocolour Series |
| ● | B33-51-727 | White | 25.40 | 6.35 | - | 8.89 | 10000 | B30 Monocolour Series |
| ● | B33-3-727 | White | 25.40 | 9.53 | - | 12.07 | 10000 | B30 Monocolour Series |
| ● | B33-5-727 | White | 25.40 | 12.70 | - | 15.24 | 7000 | B30 Monocolour Series |
| ▲ | B33-43-727 | White | 31.75 | 6.35 | - | 8.89 | 5000 | B30 Monocolour Series |

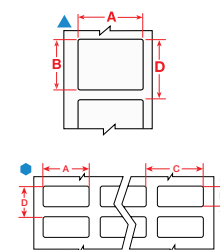

>>

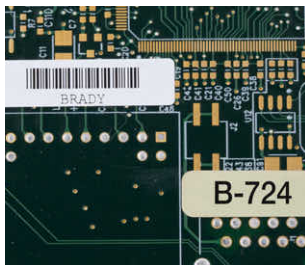

B-724, B-727, B-728, B-729 and B-777 (Continued)

Standard polyimide labels

For circuit board labels and high-temperature general identification applications

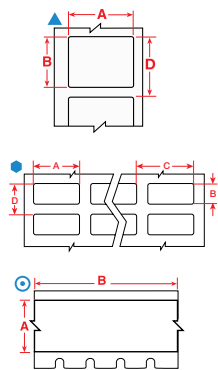

| Diagram | Order Reference | Colour | Label Width A (mm) | Label Height B (mm) | Label Length B (m) | Vertical Repeat D (mm) | Labels per Roll | Printer Ribbon Series |
|-------------------------|-----------------|--------|--------------------|---------------------|--------------------|------------------------|-----------------|-----------------------|
| ● | B33-13-727 | White | 31.75 | 6.35 | - | 9.53 | 5000 | B30 Monocolour Series |
| ▲ | B33-44-727 | White | 34.93 | 6.35 | - | 8.89 | 5000 | B30 Monocolour Series |
| ▲ | B33-45-727 | White | 38.10 | 6.35 | - | 8.89 | 5000 | B30 Monocolour Series |
| ● | B33-4-727 | White | 38.10 | 6.35 | - | 8.89 | 10000 | B30 Monocolour Series |
| ▲ | B33-72-727 | White | 44.45 | 6.35 | - | 8.89 | 5000 | B30 Monocolour Series |
| ▲ | B33-15-727 | White | 50.80 | 6.35 | - | 9.53 | 3200 | B30 Monocolour Series |
| ◎ | B30C-4000-727 | White | 101.60 | - | 39.62 | - | 1 | B30-R6000HF |
| B-728: Polyimide | | | | | | | | |
| ● | B33-70-728 | White | 6.35 | 6.35 | - | 8.89 | 20000 | B30 Monocolour Series |
| ● | B33-340-728 | White | 9.53 | 9.53 | - | 12.07 | 10000 | B30 Monocolour Series |
| ● | B33-12-728 | White | 12.70 | 11.10 | - | 13.64 | 10000 | B30 Monocolour Series |
| ● | B33-341-728 | White | 16.51 | 5.08 | - | 8.26 | 10000 | B30 Monocolour Series |
| ● | B33-1-728 | White | 19.05 | 6.35 | - | 8.89 | 10000 | B30 Monocolour Series |
| ● | B33-2-728 | White | 22.86 | 6.35 | - | 8.89 | 10000 | B30 Monocolour Series |
| ● | B33-5-728 | White | 25.40 | 12.70 | - | 15.24 | 7000 | B30 Monocolour Series |
| ● | B33-51-728 | White | 25.40 | 6.35 | - | 8.89 | 10000 | B30 Monocolour Series |
| ▲ | B33-103-728 | White | 25.40 | 6.35 | - | 8.89 | 4000 | B30 Monocolour Series |
| ● | B33-13-728 | White | 31.75 | 6.35 | - | 9.53 | 7000 | B30 Monocolour Series |
| ▲ | B33-43-728 | White | 31.75 | 6.35 | - | 8.89 | 4000 | B30 Monocolour Series |
| ● | B33-4-728 | White | 38.10 | 6.35 | - | 8.89 | 8000 | B30 Monocolour Series |
| B-729: Polyimide | | | | | | | | |
| ● | B33-70-729 | White | 6.35 | 6.35 | - | 8.89 | 20000 | B30 Monocolour Series |
| ● | B33-340-729 | White | 9.53 | 9.53 | - | 12.07 | 10000 | B30 Monocolour Series |
| ● | B33-12-729 | White | 12.70 | 11.10 | - | 13.64 | 10000 | B30 Monocolour Series |
| ● | B33-341-729 | White | 16.51 | 5.08 | - | 8.26 | 10000 | B30 Monocolour Series |
| ● | B33-1-729 | White | 19.05 | 6.35 | - | 8.89 | 10000 | B30 Monocolour Series |
| ● | B33-2-729 | White | 22.86 | 6.35 | - | 8.89 | 10000 | B30 Monocolour Series |
| ● | B33-5-729 | White | 25.40 | 12.70 | - | 15.24 | 7000 | B30 Monocolour Series |
| ● | B33-51-729 | White | 25.40 | 6.35 | - | 8.89 | 10000 | B30 Monocolour Series |
| ▲ | B33-103-729 | White | 25.40 | 6.35 | - | 8.89 | 4000 | B30 Monocolour Series |
| ● | B33-13-729 | White | 31.75 | 6.35 | - | 9.53 | 7000 | B30 Monocolour Series |
| ▲ | B33-43-729 | White | 31.75 | 6.35 | - | 8.89 | 4000 | B30 Monocolour Series |
| ● | B33-4-729 | White | 38.10 | 6.35 | - | 8.89 | 8000 | B30 Monocolour Series |
| B-777: Polyimide | | | | | | | | |
| ● | B33-340-777 | White | 9.53 | 9.53 | - | 12.07 | 10000 | B30 Monocolour Series |
| ● | B33-341-777 | White | 16.51 | 5.08 | - | 8.26 | 10000 | B30 Monocolour Series |
| ● | B33-1-777 | White | 19.05 | 6.35 | - | 8.89 | 10000 | B30 Monocolour Series |
| ● | B33-2-777 | White | 22.86 | 6.35 | - | 8.89 | 10000 | B30 Monocolour Series |
| ● | B33-51-777 | White | 25.40 | 6.35 | - | 8.89 | 10000 | B30 Monocolour Series |
| ● | B33-103-777 | White | 25.40 | 6.35 | - | 8.89 | 4000 | B30 Monocolour Series |
| ● | B33-13-777 | White | 31.75 | 6.35 | - | 9.53 | 7000 | B30 Monocolour Series |
| ● | B33-43-777 | White | 31.75 | 6.35 | - | 8.89 | 4000 | B30 Monocolour Series |
| ● | B33-4-777 | White | 38.10 | 6.35 | - | 8.89 | 8000 | B30 Monocolour Series |

B-461, B-490, B-492, B-498 & B-499 Vial & tube labels

Always have clear, legible specimen samples

- Labels are designed to withstand extreme laboratory environments.
- Resistant to laboratory solvents like Xylene, ethanol, alcohol and DMSO.
- Identification is always legible – and will not smear, fade or fall off.
- B-490, can be applied to frozen surfaces including glass and polypropylene stored in liquid nitrogen. Material must slightly overlap itself.
- B-492, can be applied to frozen surfaces including glass and polypropylene stored in liquid nitrogen.

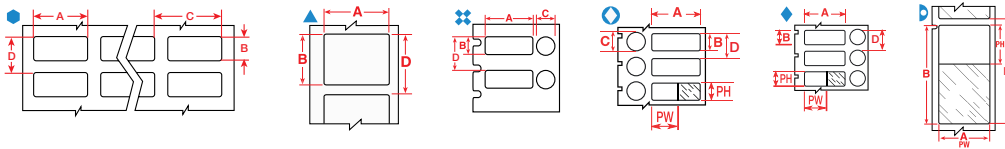

| Diagram | Material | Special Properties | Label Width A (mm) | Label Height B (mm) | Printable Area Width PW (mm) | Printable Area Height PH (mm) | Order Reference | Printer Ribbon Series | Labels per Roll |
|---------------------|----------|--------------------|--------------------|---------------------|------------------------------|-------------------------------|-----------------|-----------------------|-----------------|
| 0.5 - 0.7 ml | | | | | | | | | |
| ● | B-499 | F N A | 12.70 | 19.05 | - | - | B33-68-499 | B30 Monocolour Series | 1500 |
| ● | B-498 | F R | 12.70 | 19.05 | - | - | B33-68-498 | B30 Monocolour Series | 5000 |
| ● | B-490 | F N H L | 12.70 | 19.05 | - | - | B33-68-490 | B30 Monocolour Series | 2500 |
| ▲ | B-499 | F N A | 12.70 | 25.40 | - | - | B33-620-499 | B30-R6000HF | 1000 |
| ● | B-499 | F N A | 25.40 | 9.53 | - | - | B33-152-499 | B30 Monocolour Series | 1500 |
| ◆ | B-461 | F A H S L | 25.40 | 9.53 | 25.40 | 9.53 | B33-606-461 | B30-R4300 | 1000 |
| ▷ | B-461 | F N A H S L | 55.88 | 12.70 | 55.88 | 12.70 | B33-127-461 | B30 Monocolour Series | 1500 |
| 0.5 - 8.0 ml | | | | | | | | | |
| ▲ | B-490 | F N H L | 22.86 | 12.70 | - | - | B33-125-490 | B30 Monocolour Series | 1650 |
| 0.5 ml | | | | | | | | | |
| ● | B-499 | F N A | 6.35 | 36.50 | - | - | B33-90-499 | B30 Monocolour Series | 2500 |
| ● | B-499 | F N A | 19.05 | 6.35 | - | - | B33-1-499 | B30 Monocolour Series | 10000 |
| 0.6 ml | | | | | | | | | |
| ▲ | B-499 | F A | 22.86 | 12.70 | - | - | B33-125-499 | B30 Monocolour Series | 1500 |
| 1.0 - 2.0 ml | | | | | | | | | |
| ▷ | B-461 | F N A H S L | 15.24 | 38.10 | 15.24 | 33.02 | B33-628-461 | B30-R4300 | 2500 |
| ▷ | B-461 | F N A H S L | 15.24 | 66.68 | 15.24 | 25.40 | B33-612-461 | B30-R4300 | 1500 |
| ⊕ | B-499 | F A | 25.40 | 9.53 | - | - | B33-163-499 | B30 Monocolour Series | 1500 |
| ⊕ | B-492 | F H L | 25.40 | 9.53 | - | - | B33-163-492 | B30 Monocolour Series | 1500 |
| ⊕ | B-492 | F H L | 25.40 | 12.70 | - | - | B33-182-492 | B30 Monocolour Series | 1500 |
| ⊕ | B-492 | F H L | 25.40 | 12.70 | - | - | B33-181-492 | B30 Monocolour Series | 1500 |
| ○ | B-461 | F A H S L | 41.28 | 15.24 | 41.28 | 15.24 | B33-608-461 | B30-R4300 | 1000 |
| ▷ | B-461 | F N A H S L | 44.45 | 25.40 | 25.40 | 25.40 | B33-183-461 | B30 Monocolour Series | 2000 |
| 1.0 - 8.0 ml | | | | | | | | | |
| ● | B-499 | F N A | 19.05 | 23.80 | - | - | B33-91-499 | B30 Monocolour Series | 2500 |
| ● | B-498 | F R | 19.05 | 23.80 | - | - | B33-91-498 | B30 Monocolour Series | 2500 |
| ⊕ | B-499 | F A | 22.86 | 12.70 | - | - | B33-126-499 | B30 Monocolour Series | 1500 |
| ⊕ | B-490 | F H L | 22.86 | 12.70 | - | - | B33-126-490 | B30 Monocolour Series | 2500 |
| ● | B-498 | F R | 25.40 | 19.05 | - | - | B33-88-498 | B30 Monocolour Series | 2500 |
| ⊕ | B-492 | F H L | 41.28 | 15.24 | - | - | B33-190-492 | B30 Monocolour Series | 1500 |
| ▲ | B-492 | F N H L | 41.28 | 15.24 | - | - | B33-155-492 | B30 Monocolour Series | 1500 |
| ▲ | B-490 | F N H L | 41.28 | 15.24 | - | - | B33-155-490 | B30 Monocolour Series | 1500 |
| ▲ | B-492 | F N H L | 48.26 | 25.40 | - | - | B33-156-492 | B30 Monocolour Series | 1500 |
| ▲ | B-490 | F N H L | 48.26 | 25.40 | - | - | B33-156-490 | B30 Monocolour Series | 1500 |
| ▷ | B-461 | F N A H S L | 66.68 | 15.24 | 25.40 | 15.24 | B33-153-461 | B30 Monocolour Series | 1500 |
| 1.5 - 2.0 ml | | | | | | | | | |
| ▲ | B-492 | F N H L | 25.40 | 12.70 | - | - | B33-59-492 | B30 Monocolour Series | 2500 |
| ▷ | B-461 | F N A H S L | 41.29 | 15.24 | 25.40 | 15.24 | B33-133-461 | B30 Monocolour Series | 1500 |

>>

F Freezer environment N Liquid nitrogen environment A Autoclave environment H Hot water bath (100°C) S Self-laminating label L Low-profile (extremely thin) label R Removable

B-461, B-490, B-492, B-498 & B-499 Vial & tube labels (Continued)

Always have clear, legible specimen samples

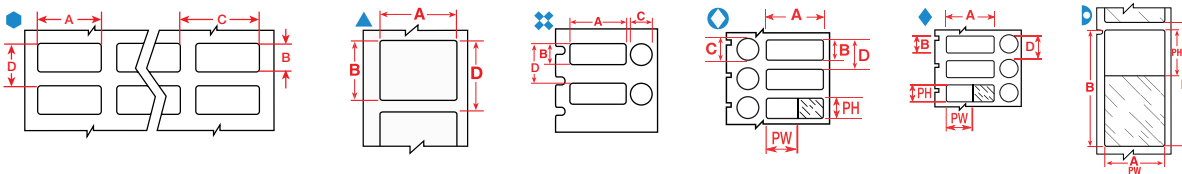

| Diagram | Material | Special Properties | Label Width A (mm) | Label Height B (mm) | Printable Area Width PW (mm) | Printable Area Height PH (mm) | Order Reference | Printer Ribbon Series | Labels per Roll |
|----------------|----------|--------------------|--------------------|---------------------|------------------------------|-------------------------------|-----------------|-----------------------|-----------------|
| 0.5 - 0.7 ml | | | | | | | | | |
| 1.5 - 8.0 ml | | | | | | | | | |
| ● | B-492 | F N H L | 25.40 | 9.53 | - | - | B33-152-492 | B30 Monocolour Series | 2500 |
| 2.0 - 4.0 ml | | | | | | | | | |
| ▷ | B-461 | F N A H S L | 15.24 | 48.26 | 15.24 | 39.88 | B33-638-461 | B30-R4300 | 2000 |
| 2.0 - 8.0 ml | | | | | | | | | |
| ▲ | B-492 | F N H L | 22.86 | 25.40 | - | - | B33-180-492 | B30 Monocolour Series | 1500 |
| ● | B-499 | F N A | 25.40 | 19.05 | - | - | B33-88-499 | B30 Monocolour Series | 2500 |
| ▲ | B-492 | F N H L | 25.40 | 25.40 | - | - | B33-179-492 | B30 Monocolour Series | 1900 |
| 4.0 - 8.0 ml | | | | | | | | | |
| ● | B-499 | F N A | 25.40 | 66.68 | - | - | B33-625-499 | B30-R6000HF | 1500 |
| 4.0 - 50.0 ml | | | | | | | | | |
| ▷ | B-461 | F N A H S L | 34.93 | 45.72 | 34.93 | 39.88 | B33-632-461 | B30-R4300 | 1500 |
| 12.0 - 24.0 ml | | | | | | | | | |
| ● | B-499 | F N A | 12.70 | 36.50 | - | - | B33-87-499 | B30 Monocolour Series | 2500 |
| ● | B-498 | F R | 12.70 | 36.50 | - | - | B33-87-498 | B30 Monocolour Series | 2500 |
| 12.0 - 50.0 ml | | | | | | | | | |
| ● | B-499 | F N A | 25.40 | 101.60 | - | - | B33-326-499 | B30 Monocolour Series | 450 |
| ● | B-498 | F R | 25.40 | 101.60 | - | - | B33-326-498 | B30 Monocolour Series | 450 |
| ▷ | B-461 | F N A H S L | 133.35 | 25.40 | 25.40 | 25.40 | B33-139-461 | B30 Monocolour Series | 650 |
| 14.0 - 15.0 ml | | | | | | | | | |
| ▲ | B-490 | F N H L | 55.88 | 38.10 | - | - | B33-157-490 | B30 Monocolour Series | 1000 |
| 15.0 - 50.0 ml | | | | | | | | | |
| ● | B-499 | F N A | 12.70 | 25.40 | - | - | B33-611-499 | B30-R6000HF | 3000 |
| ▲ | B-499 | F N A | 25.40 | 12.45 | - | - | B33-659-499 | B30-R6000HF | 1000 |
| ● | B-499 | F N A | 25.40 | 36.50 | - | - | B33-621-499 | B30-R6000HF | 3000 |
| ● | B-499 | F N A | 25.40 | 36.50 | - | - | B33-89-499 | B30 Monocolour Series | 2300 |
| ● | B-498 | F R | 25.40 | 36.50 | - | - | B33-89-498 | B30 Monocolour Series | 2300 |
| ▷ | B-461 | F N A H S L | 66.68 | 25.40 | 25.40 | 25.40 | B33-276-461 | B30 Monocolour Series | 1500 |
| ▷ | B-461 | F N A H S L | 88.90 | 38.10 | 88.90 | 38.10 | B33-134-461 | B30 Monocolour Series | 1000 |
| 50.0 ml | | | | | | | | | |
| ▲ | B-499 | F N A | 19.05 | 19.05 | - | - | B33-254-499 | B30 Monocolour Series | 1000 |
| ▲ | B-498 | F R | 19.05 | 19.05 | - | - | B33-254-498 | B30 Monocolour Series | 1000 |
| ● | B-499 | F N A | 25.40 | 12.70 | - | - | B33-5-499 | B30 Monocolour Series | 5000 |
| ● | B-498 | F R | 25.40 | 12.70 | - | - | B33-5-498 | B30 Monocolour Series | 5000 |
| ● | B-499 | F N A | 25.40 | 63.50 | - | - | B33-325-499 | B30 Monocolour Series | 700 |
| ● | B-498 | F R | 25.40 | 63.50 | - | - | B33-325-498 | B30 Monocolour Series | 700 |
| ● | B-499 | F N A | 38.10 | 101.60 | - | - | B33-327-499 | B30 Monocolour Series | 450 |
| ● | B-498 | F R | 38.10 | 101.60 | - | - | B33-327-498 | B30 Monocolour Series | 450 |
| ● | B-499 | F N A | 38.10 | 152.40 | - | - | B33-328-499 | B30 Monocolour Series | 300 |
| ● | B-498 | F R | 38.10 | 152.40 | - | - | B33-328-498 | B30 Monocolour Series | 300 |
| ▲ | B-490 | F N H L | 50.80 | 6.35 | - | - | B33-151-490 | B30 Monocolour Series | 2500 |

B-461, B-490 & B-492 Centrifuge, eppendorf & PCR tube labels

Stays put in harsh conditions and resist common laboratory chemicals

- Thin construction that prevents jamming in centrifuges and racks
- Long and short tails styles provide window for viewing liquids level in tube
- B-490 can be applied to frozen surfaces including glass and polypropylene stored in liquid nitrogen. Material must slightly overlap itself
- B-492 can be applied to frozen surfaces including glass and polypropylene stored in liquid nitrogen

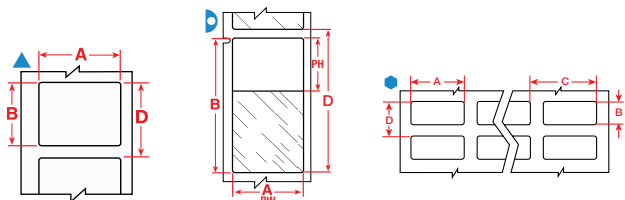

| Diagram | Material | Special Properties | Label Width A (mm) | Label Height B (mm) | Printable Area Width PW (mm) | Printable Area Height PH (mm) | Order Reference | Printer Ribbon Series | Labels per Roll |
|---------------------|----------|--------------------|--------------------|---------------------|------------------------------|-------------------------------|-----------------|-----------------------|-----------------|
| 0.5 - 0.7 ml | | | | | | | | | |
| | B-461 | F N A H S L | 5.08 | 22.86 | 5.08 | 18.23 | B33-614-461 | B30-R4300 | 2000 |
| | B-490 | F N H L | 12.70 | 19.05 | - | - | B33-68-490 | B30 Monocolour Series | 2500 |
| | B-490 | F N H L | 31.75 | 9.53 | - | - | B33-154-490 | B30 Monocolour Series | 1500 |
| | B-461 | F N A H S L | 45.72 | 9.53 | 19.05 | 9.53 | B33-123-461 | B30 Monocolour Series | 1500 |
| | B-461 | F N A H S L | 45.72 | 12.70 | 19.05 | 12.70 | B33-122-461 | B30 Monocolour Series | 1500 |
| | B-461 | F N A H S L | 55.88 | 12.70 | 19.05 | 12.70 | B33-127-461 | B30 Monocolour Series | 1500 |
| 0.5 ml | | | | | | | | | |
| | B-461 | F N A H S L | 6.35 | 27.94 | 6.35 | 22.00 | B33-627-461 | B30-R4300 | 1000 |
| 1.0 - 8.0 ml | | | | | | | | | |
| | B-492 | F N H L | 41.28 | 15.24 | - | - | B33-155-492 | B30 Monocolour Series | 1500 |
| | B-490 | F N H L | 41.28 | 15.24 | - | - | B33-155-490 | B30 Monocolour Series | 1500 |
| | B-461 | F N A H S L | 66.68 | 15.24 | 25.40 | 15.24 | B33-153-461 | B30 Monocolour Series | 1500 |
| 1.5 - 8.0 ml | | | | | | | | | |
| | B-492 | F N H L | 25.40 | 9.53 | - | - | B33-152-492 | B30 Monocolour Series | 2500 |

B-461, B-490, B-492 & B-499 Conical / Large tube labels

Use these labels for labelling larger tube sizes, while still providing the needed temperature and chemical resistance properties

- B-490 can be applied to frozen surfaces including glass and polypropylene stored in liquid nitrogen. Material must slightly overlap itself
- B-492 can be applied to frozen surfaces including glass and polypropylene stored in liquid nitrogen

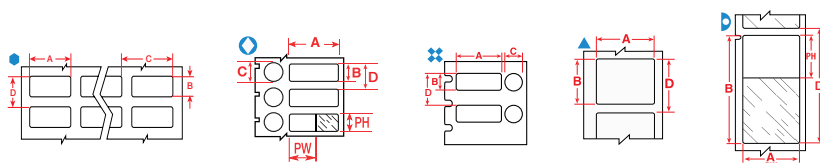

| Diagram | Material | Special Properties | Label Width A (mm) | Label Height B (mm) | Diameter C (mm) | Printable Area Width PW (mm) | Printable Area Height PH (mm) | Order Reference | Printer Ribbon Series | Labels per Roll |
|---------------------|----------|--------------------|--------------------|---------------------|-----------------|------------------------------|-------------------------------|-----------------|-----------------------|-----------------|
| 0.5 - 0.7 ml | | | | | | | | | | |
| | B-499 | F A | 12.70 | 19.05 | - | 12.70 | 19.05 | B33-68-499 | B30 Monocolour Series | 1500 |
| | B-499 | F A | 12.70 | 25.40 | - | - | - | B33-620-499 | B30-R6000HF | 1000 |
| | B-499 | F A | 25.40 | 9.53 | - | - | - | B33-152-499 | B30 Monocolour Series | 1500 |
| | B-461 | F A H S L | 55.88 | 12.70 | - | 19.05 | 12.70 | B33-127-461 | B30 Monocolour Series | 1500 |
| 0.6 ml | | | | | | | | | | |
| | B-499 | F A | 22.86 | 12.70 | - | - | - | B33-125-499 | B30 Monocolour Series | 1500 |

*AW = All white / no transparent area

>>



B-461, B-490, B-492 & B-499 Conical / Large tube labels (Continued)

Use these labels for labelling larger tube sizes, while still providing the needed temperature and chemical resistance properties

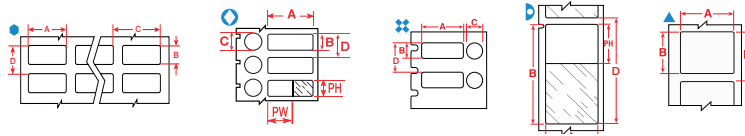

| Diagram | Material | Special Properties | Label Width A (mm) | Label Height B (mm) | Diameter C (mm) | Printable Area Width PW (mm) | Printable Area Height PH (mm) | Order Reference | Printer Ribbon Series | Labels per Roll |
|-----------------------|----------|--------------------|--------------------|---------------------|-----------------|------------------------------|-------------------------------|-----------------|-----------------------|-----------------|
| 1.0 - 2.0 ml | | | | | | | | | | |
| ▷ | B-461 | FAHSL | 15.24 | 38.10 | - | 15.24 | 33.03 | B33-628-461 | B30-R4300 | 2500 |
| ▷ | B-461 | FAHSL | 15.24 | 66.68 | - | 15.24 | 25.40 | B33-612-461 | B30-R4300 | 1500 |
| ○ | B-461 | FAHSL | 41.28 | 15.24 | 12.70 | 30.00 | 15.24 | B33-608-461 | B30-R4300 | 1000 |
| 1.0 - 8.0 ml | | | | | | | | | | |
| ● | B-499 | FA | 19.05 | 23.80 | - | - | - | B33-91-499 | B30 Monocolour Series | 2500 |
| ⊕ | B-499 | FA | 22.86 | 12.70 | 12.70 | - | - | B33-126-499 | B30 Monocolour Series | 1500 |
| ▲ | B-492 | FHL | 41.28 | 15.24 | - | - | - | B33-155-492 | B30 Monocolour Series | 1500 |
| ▲ | B-490 | FHL | 41.28 | 15.24 | - | - | - | B33-155-490 | B30 Monocolour Series | 1500 |
| ⊕ | B-492 | FHL | 41.28 | 15.24 | 9.53 | - | - | B33-190-492 | B30 Monocolour Series | 1500 |
| ▲ | B-492 | FHL | 48.26 | 25.40 | - | - | - | B33-156-492 | B30 Monocolour Series | 1500 |
| 1.5 - 2.0 ml | | | | | | | | | | |
| ▷ | B-461 | FAHSL | 15.24 | 41.28 | - | 15.24 | 25.40 | B33-133-461 | B30 Monocolour Series | 1500 |
| ▲ | B-492 | FHL | 25.40 | 12.70 | - | - | - | B33-59-492 | B30 Monocolour Series | 2500 |
| 1.5 - 8.0 ml | | | | | | | | | | |
| ● | B-492 | FHL | 25.40 | 9.53 | - | - | - | B33-152-492 | B30 Monocolour Series | 2500 |
| 2.0 - 4.0 ml | | | | | | | | | | |
| ▷ | B-461 | FAHSL | 15.24 | 48.26 | - | 15.24 | 40.00 | B33-638-461 | B30-R4300 | 2000 |
| 2.0 - 8.0 ml | | | | | | | | | | |
| ● | B-499 | FA | 25.40 | 19.05 | - | - | - | B33-88-499 | B30 Monocolour Series | 2500 |
| ▲ | B-492 | FHL | 25.40 | 25.40 | - | - | - | B33-179-492 | B30 Monocolour Series | 1900 |
| 4.0 - 8.0 ml | | | | | | | | | | |
| ● | B-499 | FA | 25.40 | 66.68 | - | - | - | B33-625-499 | B30-R6000HF | 1500 |
| 4.0 - 50.0 ml | | | | | | | | | | |
| ▷ | B-461 | FAHSL | 34.93 | 45.72 | - | 34.93 | 40.00 | B33-632-461 | B30-R4300 | 1500 |
| 12.0 - 24.0 ml | | | | | | | | | | |
| ● | B-499 | FA | 12.70 | 36.50 | - | - | - | B33-87-499 | B30 Monocolour Series | 2500 |
| 12.0 - 50.0 ml | | | | | | | | | | |
| ● | B-499 | FA | 25.40 | 101.60 | - | - | - | B33-326-499 | B30 Monocolour Series | 450 |
| ▷ | B-461 | FAHSL | 25.40 | 133.35 | - | 25.40 | 38.10 | B33-139-461 | B30 Monocolour Series | 650 |
| 15.0 - 50.0 ml | | | | | | | | | | |
| ● | B-499 | FA | 20.32 | 36.50 | - | 20.32 | - | B33-165-499 | B30 Monocolour Series | 2500 |
| ● | B-499 | FA | 25.40 | 36.50 | - | - | - | B33-621-499 | B30-R6000HF | 3000 |
| ● | B-499 | FA | 25.40 | 36.58 | - | - | - | B33-89-499 | B30 Monocolour Series | 2300 |
| ▲ | B-461 | FAHSL | 48.26 | 25.40 | - | 48.26 | 25.40 | B33-636-461AW | B30-R4300 | 2000 |
| ▲ | B-461 | FAHL | 57.15 | 19.05 | - | 57.15 | 19.05 | B33-642-461AW | B30-R4300 | 2000 |
| ▷ | B-461 | FAHSL | 66.68 | 25.40 | - | 25.40 | 25.40 | B33-276-461 | B30 Monocolour Series | 1500 |
| ▷ | B-461 | FAHSL | 88.90 | 38.10 | - | 38.10 | 31.75 | B33-134-461 | B30 Monocolour Series | 1000 |
| ▲ | B-461 | FAHSL | 88.90 | 38.10 | - | 88.90 | 38.10 | B33-650-461AW | B30-R4300 | 2000 |
| 50.0 ml | | | | | | | | | | |
| ▲ | B-499 | FA | 19.05 | 19.05 | - | - | - | B33-254-499 | B30 Monocolour Series | 1000 |
| ▷ | B-461 | FAHSL | 19.05 | 38.10 | - | 19.05 | 33.02 | B33-629-461 | B30-R4300 | 2500 |
| ● | B-499 | FA | 25.40 | 12.70 | - | - | - | B33-5-499 | B30 Monocolour Series | 5000 |
| ● | B-499 | FA | 25.40 | 63.50 | - | - | - | B33-325-499 | B30 Monocolour Series | 700 |
| ▲ | B-499 | FA | 38.10 | 19.05 | - | - | - | B33-136-499 | B30 Monocolour Series | 1500 |
| ● | B-499 | FA | 38.10 | 101.60 | - | - | - | B33-327-499 | B30 Monocolour Series | 450 |
| ● | B-499 | FA | 38.10 | 152.40 | - | - | - | B33-328-499 | B30 Monocolour Series | 300 |
| ▲ | B-490 | FHL | 50.80 | 6.35 | - | - | - | B33-151-490 | B30 Monocolour Series | 2500 |
| ▲ | B-499 | FA | 50.80 | 25.40 | - | - | - | B33-137-499 | B30 Monocolour Series | 1100 |
| ▲ | B-490 | FHL | 95.25 | 38.10 | - | - | - | B33-158-490 | B30 Monocolour Series | 1000 |

*AW = All white / no transparent area

B-461, B-490, B-492 & B-499 Vial top labels

Identify the tops of your tubes with these circular labels, or use the combined vial and vial top labels

- B-490 can be applied to frozen surfaces including glass and polypropylene stored in liquid nitrogen. Material must slightly overlap itself
- B-492 can be applied to frozen surfaces including glass and polypropylene stored in liquid nitrogen.

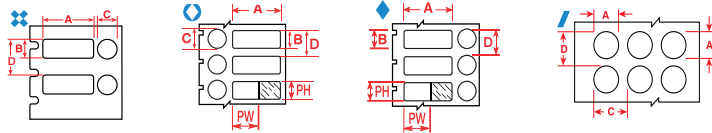

| Diagram | Material | Special Properties | Label Width A (mm) | Label Height B (mm) | Diameter C (mm) | Printable Area Width PW (mm) | Printable Area Height PH (mm) | Order Reference | Printer Ribbon Series | Labels per Roll |
|---------------|----------|--------------------|--------------------|---------------------|-----------------|------------------------------|-------------------------------|----------------------|-----------------------|-----------------|
| 0.5 - 0.7 ml | | | | | | | | | | |
| ◆ | B-461 | F A H S L | 25.40 | 9.53 | 9.53 | 20.00 | 9.53 | B33-606-461 | B30-R4300 | 1000 |
| 0.6 - 1.5 ml | | | | | | | | | | |
| / | B-499 | F A | - | - | 9.53 | - | - | B33-143-499 | B30 Monocolour Series | 1500 |
| / | B-492 | F H L | - | - | 9.53 | - | - | B33-143-492 | B30 Monocolour Series | 1500 |
| 0.6 - 50.0 ml | | | | | | | | | | |
| / | B-499 | F A | - | - | 9.53 | - | - | B33-602-499 | B30-R6000HF | 3000 |
| / | B-499 | F A | - | - | 9.53 | - | - | B33-602-499YL | B30-R6000HF | 3000 |
| / | B-461 | F A H S L | - | - | 9.53 | - | - | B33-602-461AW | B30-R4300 | 3000 |
| / | B-499 | F A | - | - | 12.70 | - | - | B33-603-499 | B30-R6000HF | 3000 |
| / | B-499 | F A | - | - | 12.70 | - | - | B33-603-499YL | B30-R6000HF | 3000 |
| / | B-461 | F A H S L | - | - | 15.24 | - | - | B33-604-461AW | B30-R4300 | 3000 |
| 1.0 - 2.0 ml | | | | | | | | | | |
| / | B-499 | F A | - | - | 12.70 | - | - | B33-144-499 | B30 Monocolour Series | 1500 |
| / | B-492 | F H L | - | - | 12.70 | - | - | B33-144-492 | B30 Monocolour Series | 1500 |
| / | B-490 | F H L | - | - | 12.70 | - | - | B33-144-490 | B30 Monocolour Series | 2500 |
| ⊛ | B-499 | F A | 25.40 | 9.53 | 9.53 | - | - | B33-163-499 | B30 Monocolour Series | 1500 |
| ⊛ | B-492 | F H L | 25.40 | 9.53 | 9.53 | - | - | B33-163-492 | B30 Monocolour Series | 1500 |
| ⊛ | B-492 | F H L | 25.40 | 12.70 | 11.18 | - | - | B33-182-492 | B30 Monocolour Series | 1500 |
| ○ | B-461 | F A H S L | 41.28 | 15.24 | 12.70 | 30.00 | 15.24 | B33-608-461 | B30-R4300 | 1000 |
| 1.0 - 8.0 ml | | | | | | | | | | |
| ⊛ | B-499 | F A | 22.86 | 12.70 | 12.70 | - | - | B33-126-499 | B30 Monocolour Series | 1500 |
| ⊛ | B-490 | F H L | 22.86 | 12.70 | 12.70 | - | - | B33-126-490 | B30 Monocolour Series | 2500 |
| ⊛ | B-492 | F H L | 41.28 | 15.24 | 9.53 | - | - | B33-190-492 | B30 Monocolour Series | 1500 |

* AW = All white / no transparent area



B-7425 Polypropylene labels

- Offers excellent all-purpose sample traceability
- Stays attached to vials, tubes, slides and well plates
- Remains legible when exposed to chemicals and extreme temperatures

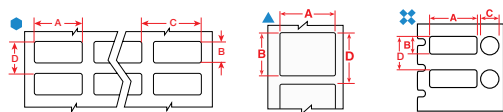

| Diagram | Material | Special Properties | Label Width A (mm) | Label Height B (mm) | Diameter C (mm) | Printable Area Width PW (mm) | Printable Area Height PH (mm) | Order Reference | Printer Ribbon Series | Labels per Roll |
|--------------|----------|--------------------|--------------------|---------------------|-----------------|------------------------------|-------------------------------|-----------------|-----------------------|-----------------|
| ▲ | B-7425 | F A H | 50.80 | 12.70 | - | 50.80 | 12.70 | B33-53-7425 | B30 Monocolour Series | 2000 |
| 0.5 - 0.7 ml | | | | | | | | | | |
| ● | B-7425 | F A H | 25.40 | 9.53 | - | 25.40 | 9.53 | B33-152-7425 | B30 Monocolour Series | 2000 |
| 0.5 - 8.0 ml | | | | | | | | | | |
| ⊕ | B-7425 | F A H | 25.40 | 9.53 | 9.53 | 25.40 | 9.53 | B33-249-7425 | B30 Monocolour Series | 1500 |
| ▲ | B-7425 | F A H | 25.40 | 12.70 | 11.18 | 25.40 | 9.53 | B33-251-7425 | B30 Monocolour Series | 1500 |
| 1.0 - 2.0 ml | | | | | | | | | | |
| ▲ | B-7425 | F A H | 20.96 | 6.35 | - | 20.96 | 6.35 | B33-257-7425 | B30 Monocolour Series | 1500 |
| 1.0 - 8.0 ml | | | | | | | | | | |
| ● | B-7425 | F A H | 25.40 | 19.05 | - | 25.40 | 19.05 | B33-88-7425 | B30 Monocolour Series | 2000 |
| ▲ | B-7425 | F A H | 38.10 | 44.45 | - | 38.10 | 44.45 | B33-258-7425 | B30 Monocolour Series | 900 |
| 1.0 ml | | | | | | | | | | |
| ▲ | B-7425 | F A H | 33.02 | 15.24 | - | 33.02 | 15.24 | B33-256-7425 | B30 Monocolour Series | 1500 |
| 1.5 - 2.0 ml | | | | | | | | | | |
| ▲ | B-7425 | F A H | 25.40 | 12.70 | - | 25.40 | 12.70 | B33-59-7425 | B30 Monocolour Series | 2000 |
| 2.0 ml | | | | | | | | | | |
| ● | B-7425 | F A H | 38.10 | 12.70 | - | 38.10 | 12.70 | B33-37-7425 | B30 Monocolour Series | 1500 |
| 15.0 ml | | | | | | | | | | |
| ▲ | B-7425 | F A H | 38.10 | 25.40 | - | 38.10 | 25.40 | B33-235-7425 | B30 Monocolour Series | 1250 |
| 50.0 ml | | | | | | | | | | |
| ▲ | B-7425 | F A H | 25.40 | 25.40 | - | 25.40 | 25.40 | B33-179-7425 | B30 Monocolour Series | 1500 |
| ▲ | B-7425 | F A H | 38.10 | 19.05 | - | - | - | B33-136-7425 | B30 Monocolour Series | 1500 |
| ⊕ | B-7425 | F A H | 50.80 | 6.35 | - | 50.80 | 6.35 | B33-151-7425 | B30 Monocolour Series | 2000 |
| ▲ | B-7425 | F A H | 50.80 | 25.40 | - | 50.80 | 25.40 | B33-137-7425 | B30 Monocolour Series | 1500 |



B-7425-AC Sterilisation indicating labels

Label confirms successful sterilisation

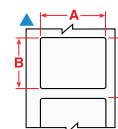

| Diagram | Material | Special Properties | Label Width A (mm) | Label Height B (mm) | Printable Area Width PW (mm) | Order Reference | Printer Ribbon Series | Labels per Roll |
|---------|----------|--------------------|--------------------|---------------------|------------------------------|-----------------|-----------------------|-----------------|
| 15.0 ml | | | | | | | | |
| ▲ | B-7425 | | 38.10 | 25.40 | 38.10 | B33-235-7425-AC | B30 Monocolour Series | 1250 |
| 50.0 ml | | | | | | | | |
| ▲ | B-7425 | | 50.80 | 25.40 | 50.80 | B33-137-7425-AC | B30 Monocolour Series | 1500 |

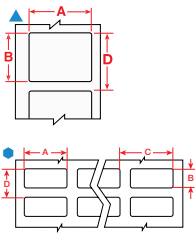

B-488 Well plate labels

Our well plate labels guarantee crystal clear text and barcoding for most laboratory environments

- Chemically-resistant polyester made to fit common well plate sizes



| Diagram | Material | Special Properties | Label Width A (mm) | Label Height B (mm) | Order Reference | Printer Ribbon Series | Labels per Roll |
|---------|----------|--------------------|--------------------|---------------------|-----------------|-----------------------|-----------------|
| | B-488 | F A | 22.86 | 19.05 | B33-616-488 | B30-R4300 | 3000 |
| | B-488 | F A | 22.86 | 22.86 | B33-617-488 | B30-R4300 | 3000 |
| | B-488 | F A | 48.26 | 6.35 | B33-635-488 | B30-R4300 | 2000 |

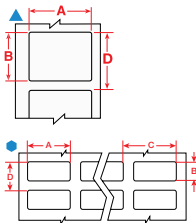

B-498 Re-Identify Tissue Cassettes Labels

Tissue cassettes are often re-identified when labs collect samples from various biorepositories. Typically, each laboratory has its own unique way of identifying samples, which creates a need to re-identify samples in a common way. The B-498 labels can be applied directly onto the cassettes, on pure paraffin wax and on top of another label or identifier.



| Diagram | Material | Special Properties | Label Width A (mm) | Label Height B (mm) | Order Reference | Printer Ribbon Series | Labels per Roll |
|---------|----------|--------------------|--------------------|---------------------|-----------------|-----------------------|-----------------|
| | B-498 | F R | 19.05 | 6.35 | B33-1-498 | B30 Monocolour Series | 5000 |
| | B-498 | F R | 19.05 | 19.05 | B33-254-498 | B30 Monocolour Series | 1000 |

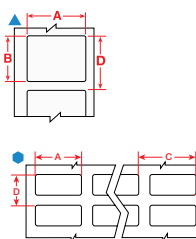

B-481 & B-488 Slide labels

Designed to provide crisp and clear sample identification throughout the sample generation, inspection and storage process

- Resistant to xylene, alcohol and DMSO



| Diagram | Material | Special Properties | Label Width A (mm) | Label Height B (mm) | Order Reference | Printer Ribbon Series | Labels per Roll |
|---------|----------|--------------------|--------------------|---------------------|-----------------|-----------------------|-----------------|
| | B-481 | F H | 22.86 | 9.53 | B33-195-481 | B30 Monocolour Series | 3000 |
| | B-488 | F A | 22.86 | 19.05 | B33-616-488 | B30-R4300 | 3000 |
| | B-481 | F H | 22.86 | 19.05 | B33-194-481 | B30 Monocolour Series | 2000 |
| | B-488 | F A | 22.86 | 22.86 | B33-617-488 | B30-R4300 | 3000 |
| | B-481 | F H | 22.86 | 22.86 | B33-141-481 | B30 Monocolour Series | 1500 |
| | B-488 | F A | 48.26 | 6.35 | B33-635-488 | B30-R4300 | 2000 |

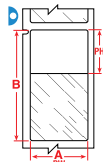

B-427 Straw labelling

These self-laminating labels protect the printed information for lasting identification

| Diagram | Material | Special Properties | Label Width A (mm) | Label Height B (mm) | Printable Area Width PW (mm) | Printable Area Height PH (mm) | Order Reference | Printer Ribbon Series | Labels per Roll |
|---------|----------|--------------------|--------------------|---------------------|------------------------------|-------------------------------|-----------------|-----------------------|-----------------|
| 0.3 ml | | | | | | | | | |
| ▶ | B-427 | F N S | 25.40 | 25.40 | 25.40 | 9.53 | B33-211-427 | B30-R4300 | 3000 |
| ▶ | B-427 | F N S | 25.40 | 25.40 | 25.40 | 9.53 | B33-116-427 | B30 Monocolour Series | 2500 |
| ▶ | B-427 | F N S | 44.45 | 38.10 | 44.45 | 12.70 | B33-121-427 | B30 Monocolour Series | 1000 |
| 0.5 ml | | | | | | | | | |
| ▶ | B-427 | F N S | 25.40 | 63.50 | 25.40 | 19.05 | B33-511-427 | B30-R4300 | 1500 |
| ▶ | B-427 | | 25.40 | 31.75 | - | - | B33-117-427 | B30 Monocolour Series | 2000 |

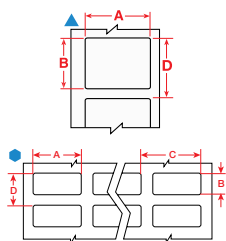

B-488 Bottles, flasks, dishes and general identification

Used to identify a variety of common laboratory glassware items and other consumables

| Diagram | Material | Special Properties | Label Width A (mm) | Label Height B (mm) | Order Reference | Printer Ribbon Series | Labels per Roll |
|---------|----------|--------------------|--------------------|---------------------|-----------------|-----------------------|-----------------|
| ▲ | B-488 | F A | 22.86 | 19.05 | B33-616-488 | B30-R4300 | 3000 |
| ● | B-488 | F A | 22.86 | 22.86 | B33-617-488 | B30-R4300 | 3000 |
| ▲ | B-488 | F A | 48.26 | 6.35 | B33-635-488 | B30-R4300 | 2000 |

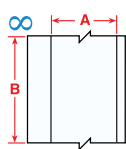

B-403 Water dissolvable label

The label dissolves within 30 seconds exposure to water

| Diagram | Material | Special Properties | Label Width A (mm) | Label Length B (m) | Order Reference | Printer Ribbon Series | Labels per Roll |
|---------|----------|--------------------|--------------------|--------------------|------------------|-----------------------|-----------------|
| ∞ | B-403 | R | 28.58 | 30.48 | B30C-1125-403-WT | B30-R4300 | 1 |
| ∞ | B-403 | R | 57.15 | 30.48 | B30C-2250-403-WT | B30-R4300 | 1 |
| ∞ | B-403 | R | 76.20 | 30.48 | B30C-3000-403-WT | B30-R4300 | 1 |
| ∞ | B-403 | R | 101.60 | 30.48 | B30C-4000-403-WT | B30-R4300 | 1 |

This section provides a quick reference to Brady materials listed throughout this catalogue, including basic attributes, applications and regulatory compliance where applicable. For more detailed material attribute and performance information, please refer to the material's Technical Data Sheet, listed at www.bradyeurope.com/tds.

| Brady Material No. | Material | Finish | Colour | Temp (°C) (Tested for 30 days) | | Properties & Applications | Approval/Compliance |
|--------------------|---|--------|--------------------|-----------------------------------|----------|--|---|
| | | | | Min. | Max. | | |
| B-342 | Heat-shrink Polyolefin Sleeve | Matt | White | -55 °C | 130.6 °C | 3:1 ratio heat shrinkable wire marking sleeve that fits snugly around wires for identification and protection. Fade-resistant and flame retardant. Also available in yellow and black. | UL Recognised to UL224; SAE-AMS-DTL-23053/5 C (Class 1); SAE-AS-81531 |
| B-345 | High Temperature Heat-shrink Polyvinylidene Fluoride Sleeve | Matt | White | -70 °C | 130.6 °C | 2:1 ratio heat shrinkable wire marking sleeve specifically designed for high temperature and low vacuum outgassing applications. These heat shrinkable wire marking sleeves are made from irradiated high temperature PVDF. Also available in black. | NASA SP-R-0022A Outgassing Performance; SAE-AMS-DTL-23053/18 (Class 2); SAE-AS-81531; MIL-STD-202G Method 215K |
| B-348 | Polyolefin | Matt | White | -55 °C | 135 °C | Mass Transit Tag complies with minimal smoke and halogen emission requirements of the most strict underground norms for mass transit vehicles. The tag is a practical solution for mass transit manufacturers to identify thick cables and cable bundles. | – |
| B-403 | Paper | Matt | Black on White | -70 °C | 100 °C | White dissolvable paper. Dissolves completely in water leaving no adhesive residue, ideal for temporary labelling applications | – |
| B-413 | Metallic, Non-metal Polyester | Satin | Light Grey | -70 °C | 110 °C | Thermal transfer printable polyester material with metallic-looking finish (non-metallised). Ideal for barcoded asset tracking and rating plate applications. | UL Recognised; cUL Recognised |
| B-417 | Self-laminating Vinyl | Matt | White, Transparent | -40 °C | 70 °C | Keep your wire identification secure with this self-laminating marker with extra-strong adhesive. The extra-strong adhesive makes these markers ideal for small-diameter wires. Features a white printable area and a clear tail that wraps around the marker. | UL Recognised to UL969 Labelling and Marking Standard when printed with the Brady Series R4300 and R7950 ribbons. See UL files MH62024 for specific details. Brady customers should specify at purchase if they require UL Recognised B-417 labels. Brady sells both UL Recognised B-417 labels and non-approved labels depending on customer requirements |
| B-422 | Polyester | Gloss | White | -40 °C | 100 °C | White material stock with glossy finish and 2 mils of adhesive for rough surface applications, including low surface energy plastics. Designed to withstand solvent exposure. UL rated for surfaces commonly used in solar panel manufacturing. Also used for component identification, barcoding, asset and inventory tracking. | UL Recognised; CSA Accepted |
| B-423 | Polyester | Gloss | White | -70 °C | 110 °C | White polyester thermal transfer printable material with a glossy finish. Widely used for component identification, barcoding, asset and inventory tracking. UL rated for surfaces commonly used in solar panel manufacturing. | UL Recognised; CSA Accepted; AGA Approved; Halogen Free (DIN VDE 0472/part 815) |
| B-424 | Paper | Matt | White | -40 °C | 50 °C | White paper material with matt finish and smooth top coat finish for thermal transfer printing. Good contrast and smear resistance for thermal barcode printing. Used for general purpose labeling applications | – |
| B-425A | Polypropylene | Matt | White | -70 °C | 80 °C | White polypropylene material stock with matt finish for thermal transfer printing or write-on applications. Excellent solvent resistance and print performance; not recommended for long-term outdoor use. | UL Recognised; CSA Accepted; Halogen Free (DIN VDE 0472/part 815) |
| B-427 | Self-laminating Vinyl | Matt | White, Transparent | -40 °C | 60 °C | Thermal transfer printable, self-laminating material. These labels have a printable area with a clear "tail" that wraps around the marker. The "tail" serves as overlaminates to protect the print. Superior resistance to abrasion, solvents, water, oil and dirt. Also available in grey, brown, green, yellow, blue, red, purple, orange. | UL Recognised to UL969 Labelling and Marking Standard when printed with the Brady Series R4300 and R6200 ribbons. See UL files MH17154 for specific details. Brady customers should specify at purchase if they require UL Recognised B-427 labels. Brady sells both UL Recognised B-427 labels and non-approved labels depending on customer requirements. |
| B-428 | Metallised Polyester | Matt | Light Grey | -70 °C | 120 °C | Thermal transfer printable metallised polyester with matt finish. Withstands solvents and variable temperatures. Excellent for serial and rating plate applications with name-plate quality and a metal-looking finish. | UL Recognised; CSA Accepted; Halogen Free (DIN VDE 0472/part 815) |

Master material index

| Brady Material No. | Material | Finish | Colour | Temp (°C) (Tested for 30 days) | | Properties & Applications | Approval/Compliance |
|--------------------|--|--------|--------------------|-----------------------------------|--------|---|---|
| | | | | Min. | Max. | | |
| B-428/B-966B | Metallised Polyester with Polyester Overlamine | Gloss | Silver | -70 °C | 120 °C | A Metallised polyester label that comes with a separate overlamine to be applied over the label once printed. This way the label remains clear and easy-to-read, even in harsh environments. Overlamine is a clear polyester (B-966B) that extends outside of label on each side when applied. | – |
| B-430 | Polyester | Gloss | Transparent | -70 °C | 100 °C | Translucent, high performance polyester material with a glossy finish. Thermal transfer printable. | UL Recognised; CSA Accepted |
| B-432 | Polyester | Gloss | Transparent | -40 °C | 100 °C | Translucent, high performance polyester material with a glossy finish. Thermal transfer printable. Very similar to B-430, but has a thicker layer of acrylic adhesive for better adherence to rough surface applications. | UL Recognised; CSA Accepted |
| B-434A | Metallised Polyester | Gloss | Silver | -40 °C | 90 °C | Metallised polyester with a glossy finish and a thicker layer of adhesive for better adherence to rough surface applications. Withstands numerous solvents while maintaining excellent image quality. | UL Recognised; CSA Accepted |
| B-435A | Metallised Polyester | Gloss | Silver | -40 °C | 90 °C | Printable metallised polyester withstands numerous solvents and variable temperatures. Ideal for serial and rating plate applications with name-plate quality and a metal looking finish. | UL Recognised; CSA Accepted |
| B-437 | Polyvinylfluoride | Matt | White | -70 °C | 135 °C | Polyvinylfluoride label material with matt finish. Used in wire and cable identification applications where self-extinguishing features are required. This label material utilises an adhesive for heavy-duty applications and is available in continuous or die-cut formats. Excellent resistance to water, oil and other common fluids. Also available in yellow. | MIL-M-87958 Pressure Sensitive Adhesive Wire or Cable Marker and Identification specification |
| B-438 | Tamper-evident Metallised Polyester | Matt | Silver | -40 °C | 40 °C | Metallised polyester material with matt finish. Leaves a checkerboard footprint on the surface when removed; the pattern also appears on the top of the label to prevent it from being reused. | UL Recognised |
| B-439 | Vinyl | Gloss | Green | -70 °C | 40 °C | Available in Blue, Green, Orange, Red, White and Yellow | – |
| B-461 | Self-laminating Polyester | Matt | White, Transparent | -196 °C | 110 °C | Permanent adhesive; suitable for liquid nitrogen application if material is wrapped around itself, as in self-lamination; write-on capabilities. Temperature range increases to 121 °C when used in autoclave process | – |
| B-472 | Polyimide | Matt | White | -70 °C | 100 °C | Cable and wire bundle applications and label applications where self-extinguishing properties are required | – |
| B-480A | Metallic, Non-metal Polyester | Satin | Silver | -70 °C | 110 °C | | UL Recognised; cUL Recognised |
| B-481 | StainerBondz™ Polyester | Matt | White | -80 °C | 130 °C | White polyester will remain resistant when exposed to xylene and other chemicals that are commonly used in the slide staining process | – |
| B-482 | Polyester | Matt | White | | | The B-482 label material, combined with Brady's R6400 ribbon, provides the durability and print quality that histology and anatomic pathology labs need for accurate, identifiable specimen labelling. Paraffin and solvent resistant. | – |
| B-483A | Polyester | Gloss | White | -40 °C | 120 °C | White polyester thermal transfer printable material with glossy finish and aggressive adhesive specifically designed for powder coated surfaces. | UL Recognised; CSA Accepted |
| B-484A | Polyester | Gloss | White | -40 °C | 120 °C | White polyester thermal transfer printable material, similar to B-483, but with thinner construction for curved or angled surfaces. Offers aggressive adhesive for adhesion to textured metals and low surface energy plastics. | UL Recognised |
| B-486B | Metallised Polyester | Matt | Light Grey | -40 °C | 120 °C | Thermal transfer printable metallised polyester material. Designed for high adhesion to textured metals, powder coated surfaces and low surface energy plastics. | UL Recognised; CSA Accepted |
| B-488 | Polyester | Matt | White | -40 °C | 145 °C | White polyester thermal transfer printable material, similar to B-423, but with matt finish. Widely used for component identification, barcoding, asset and inventory tracking. | UL Recognised; CSA Accepted |
| B-489A | Polyester | Matt | White | -40 °C | 120 °C | White polyester thermal transfer printable material, similar to B-483, but with matt finish. Aggressive adhesive specifically designed for powder coated surfaces. | UL Recognised; CSA Accepted |

| Brady Material No. | Material | Finish | Colour | Temp (°C) (Tested for 30 days) | | Properties & Applications | Approval/Compliance |
|--------------------|--------------------------|------------|------------------------|-----------------------------------|--------|--|--|
| | | | | Min. | Max. | | |
| B-490 | FreezerBondz™ Polyester | Matt | White | -196 °C | 130 °C | Can be applied to frozen surfaces including glass and polypropylene stored in liquid nitrogen, except for Vial Tops. Material must slightly overlap itself. | – |
| B-492 | FreezerBondz™ Polyester | Matt | White | -196 °C | 110 °C | Ultra thin; can label frosted/frozen (with overlap) or room temperature labels and lasts in liquid nitrogen and hot water baths | – |
| B-498 | Vinyl Cloth | Semi-gloss | White | -40 °C | 80 °C | White vinyl cloth label material with glossy finish. The adhesive and cloth backing give excellent holding power, while being repositionable and removing cleanly. | UL Recognised |
| B-499 | Nylon Cloth | Matt | Black on White | -40 °C | 90 °C | Nylon cloth material with matt finish. The adhesive allows labelling in environments with heat, cold, oil and dirt. Also available in yellow. | UL Recognised; CSA Accepted; Halogen Free (DIN VDE 0472/part 815) Approvals are for White material only |
| B-509 | Magnetic Polyester | Matt | White | -18 °C | 70 °C | Magnetic Back Polyester is used for temporary, reusable and movable signs | – |
| B-526 | Phosphorescent Polyester | Gloss | Photoluminescent Green | -40 °C | 60 °C | BradyGlo™ High Intensity laminate is designed to provide high adhesion and luminance for egress marking in low light areas in and along stairwells of public buildings, exit and directional signs, identification of fire alarms and extinguishers, low location egress pathway markings, and directional systems for escape or evacuation routes. | New York Local Law 26 RS 6-1 & 6-1A; City of New York, Department of Buildings MEA No. 467-06-M UV: 46-9-7 |
| B-549 | Polyester | Gloss | White | -40 °C | 100 °C | Flexible, dimensionally stable, low temperature, pressure sensitive adhesive tape for permanent application. Adhesive can be applied at temperatures down to -10°F (-23°C). | – |
| B-551 | Polyester Tag | Matt | White | -40 °C | 89 °C | Tag material used for marking on-the-spot warning of dangerous conditions | Complies to OSHA 1910.145(f) when printed with required signal word and major message. |
| B-565 | Metallised Polyester | Matt | Silver | -40 °C | 110 °C | Designed for applications like identification labels or rating and serial plates that utilise barcodes, alphanumerics, graphic symbols and logos and require nameplate-like quality | – |
| B-569 | Polyester | Gloss | Green | -40 °C | 100 °C | Designed for use on stainless steel pipes in harsh environments such as the Pulp and Paper Industry | – |
| B-581 | Vinyl | Gloss | White | -40 °C | 82 °C | Only indoor use, where frequent repositioning is required | – |
| B-584 | Reflective Tape | Gloss | Orange | -40 °C | 70 °C | Suitable for outdoor use. Also available in silver and yellow. | – |
| B-593 | Polyester | Gloss | White | -20 °C | 100 °C | EPREP (Engraved Panel REplacement labels) are designed for patch panel identification in identifying external push-buttons, switches and internal connection points. Also available in black, green, red, silver and yellow. | UL Recognised; cUL Recognised |
| B-595 | Vinyl | Gloss | White | -40 °C | 82 °C | Durable, low-shrink vinyl with our most aggressive adhesive. Conforms to irregular, curved, rough and highly textured surfaces (painted cinder blocks, uneven wood, textured plastics, paper-jacketed pipes, powder-coated surfaces). Adheres to "difficult" low-surface energy items (PVC piping, blow-moulded equipment cases, ABS plastics, recycled plastics). Available in a wide range of colours. | BS5609:1986 Section 2 and section 3 |
| B-618 | Polyester | Matt | White | -70 °C | 120 °C | | UL Recognised; cUL Recognised |
| B-717 | Polyimide | Gloss | White | -70 °C | 300 °C | White polyimide material with glossy finish and ultra-durable adhesive. Used in printed circuit board and electronic component pre-process labelling. Designed for use with extreme wash protocol and cleaning chemicals. Surface resistivity values in the recommended range for dissipative ESD packing materials. | UL Recognised; Meets the requirements of ANSI/ESD S541-2008 (between 10 ⁴ and 10 ¹¹ ohms) for dissipative ESD packaging materials; Meets the performance requirements of MIL-STD-202G, Method 215K |
| B-718 | Polyimide | Gloss | White | -70 °C | 300 °C | White polyimide material, low profile (1 mil thickness), with glossy finish and ultra-durable adhesive. Used in printed circuit board and electronic component pre-process labelling. Designed for use with extreme wash protocol and cleaning chemicals. Surface resistivity values in the recommended range for dissipative ESD packing materials. | UL Recognised; Meets the requirements of ANSI/ESD S541-2008 (between 10 ⁴ and 10 ¹¹ ohms) for dissipative ESD packaging materials; Meets the performance requirements of MIL-STD-202G, Method 215K |

| Brady Material No. | Material | Finish | Colour | Temp (°C) (Tested for 30 days) | | Properties & Applications | Approval/Compliance |
|--------------------|--------------------------------------|--------|--|-----------------------------------|--------|--|--|
| | | | | Min. | Max. | | |
| B-719 | Polyimide | Matt | White | -70 °C | 300 °C | White polyimide material with matt finish and ultra-durable adhesive. Used in printed circuit board and electronic component pre-process labelling. Designed for use with extreme wash protocol and cleaning chemicals. Surface resistivity values in the recommended range for dissipative ESD packing materials. | UL Recognised; Meets the requirements of ANSI/ESD S541-2008 (between 10 ⁹ and 10 ¹¹ ohms) for dissipative ESD packaging materials; Meets the performance requirements of MIL-STD-202G, Method 215K |
| B-724 | Polyimide | Matt | Amber | -70 °C | 300 °C | Amber polyimide material with matt finish and ultra-durable adhesive. Used in printed circuit board and electronic component pre-process labelling. Designed for use with extreme wash protocol and cleaning chemicals. | Meets the performance requirements of MIL-STD-202G, Notice 12, Method 215K; Meets the requirements of SAE AS81531 Marking of Electrical Insulating Material |
| B-727 | Polyimide | Gloss | White | -70 °C | 300 °C | White polyimide material with glossy finish and ultra-durable adhesive. Used in printed circuit board and electronic component pre-process labelling. Designed for use with extreme wash protocol and cleaning chemicals. | UL Recognised; Meets the performance requirements of MIL-STD-202G, Notice 12, Method 215K; Dibutyltin and Dioctyltin free. |
| B-728 | Polyimide | Matt | White | -70 °C | 300 °C | White polyimide material with matt finish and ultra-durable adhesive. Used in printed circuit board and electronic component pre-process labelling. Designed for use with extreme wash protocol and cleaning chemicals. | UL Recognised; Meets the performance requirements of MIL-STD-202G, Notice 12, Method 215K |
| B-729 | Polyimide | Matt | White | -70 °C | 300 °C | White polyimide material, low profile (1 mil thickness), with matt finish and ultra-durable adhesive. Used in printed circuit board and electronic component pre-process labelling. Designed for use with extreme wash protocol and cleaning chemicals. | UL Recognised; Meets the performance requirements of MIL-STD-202G, Notice 12, Method 215K |
| B-7425 | Polypropylene | Matt | Black on White | -80 °C | 70 °C | White Polypropylene material. Ideal for laboratory identification such as vials, centrifuge tubes and test tubes. For freezer or liquid nitrogen applications, B-7425 must be applied prior to being frozen. | — |
| B-7563 | Metallised Polyester | Satin | Silver | -40 °C | 135 °C | Thermal transfer printable metallised polyester withstands numerous solvents and variable temperatures. Ideal for serial and rating plate applications with name-plate quality and a metal looking finish. | UL Recognised |
| B-7569 | Vinyl | Gloss | White | -20 °C | 75 °C | Used for Pipe Markers, Arrow Tape, Warehouse Marking, Floor Marking, Warning Panels, Safety Signs and Hazardous Substance Identification. Available in a wide range of colours. | BS5609:1986 Section 2 and section 3 |
| B-7597 | Polyethylene Tag | Matt | White | -40 °C | 100 °C | Polyethylene tag material. Resists tearing and the topcoat resists smudging and abrasion. Halogen free material. | Halogen Free (DIN VDE 0472/part 815) |
| B-7598 | Polyester Tag | Gloss | White, Yellow, Red, Green, Silver, Black, Blue | -40 °C | 100 °C | A general identification polyester tag for cables exposed to extreme conditions. Up to 10 years outdoor durability. Also available in black, blue, green, red, silver and yellow. | Parts supplied in White, Black or Silver are Halogen Free as per IEC 61249-2-21 (2003-11) |
| B-7599 | Polyethylene Tag | Matt | Yellow | -40 °C | 50 °C | White polyethylene tag material. Rapido™ Wiremarking Sleeves are fast and easy to apply. Simply squeeze the edges of the material together, thread your wire through the holes and pull away the wire to release the marker. | — |
| B-7641 | Heat-shrink Polyolefin Sleeve | Matt | White | -55 °C | 105 °C | 2:1 ratio heat shrinkable, zero halogen wire marking sleeves. The wire marking sleeves offer outstanding fire safety properties and minimal smoke emission. Also available in yellow. | BS-6853 (1999) Vehicle Category 1A; EN-45545-2, requirement 24, Vehicle Category HL3; Zero Halogen |
| B-7642 | Heat-shrink Polyolefin Sleeve | Matt | White | -40 °C | 120 °C | 2:1 ratio heat shrinkable wire marking sleeves. The sleeves are high-temperature rated, highly flame retardant, and very flexible. | UL 224; SAE-AMS-DTL-23053/5 (Class 1 and 3); SAE-AS-81531; MIL-STD-202 Method 215K; Tested per ASTM E162; ASTM E662 |
| B-7643 | Thermoplastic Polyether Polyurethane | Matt | White, Yellow | -40 °C | 90 °C | Thermal transfer and dot matrix printable wire and cable bundle tag for harsh environments. Low halogen material. Also available in black, orange, red and yellow. | Halogen free per IEC 61249-2-21 (2003-11), Adherence: SAE-AS81531-1998, Flame retardant: MIL-STD-202G |
| B-7696 | Vinyl Tag | Gloss | White, Yellow | -40 °C | 70 °C | Brady DuraSleeve® printable inserts create a durable legend. The rigid construction of the DuraSleeve wire marking system provides inserts that can easily be inserted into a clean carrier. The legend can be changed before or after termination. Also available in yellow. | UL94 V0 |

| Brady Material No. | Material | Finish | Colour | Temp (°C) (Tested for 30 days) | | Properties & Applications | Approval/Compliance |
|--------------------|----------------------------|--------|--------|-----------------------------------|--------|---|--|
| | | | | Min. | Max. | | |
| B-777 | Polyimide | Gloss | White | -70 °C | 300 °C | The B-777 Ultratemp label for harsh washing processes works seamlessly with the BSPT™61 Print and Apply System, the ALF Label Feeder and other auto-apply systems. Together they provide a reliable and flexible on-site traceability solution for high heat applications in manufacturing. | UL Recognised to UL969 Labelling and Marking Standard when printed with Brady Series R6300 ribbon. See UL file MH25991 for specific details. |
| B-8423 | Polyester | Satin | White | -70 °C | 110 °C | Polyester material with satin finish, economical alternative to B-423. Used for component identification, barcoding, asset and inventory tracking. Also available in yellow. | UL Recognised; CSA Accepted |
| B-854 | Metal Detectable Polyester | Matt | White | -40 °C | 110 °C | Tough against harsh washdown environments; metal detectable. Also available in yellow. | – |
| B-855 | Polyester | Matt | White | -40 °C | 110 °C | Tough against harsh washdown environments. Also available in yellow. | – |
| B-8591 | Polymer | Gloss | White | -70 °C | 110 °C | B-8591 toughest outdoor label is suited for smooth, textured/rough or highly textured/low energy surfaces. | – |

▶ Need more information? View the technical data sheets Brady offers online access to technical data sheets for all Brady materials. View by a specific B-Number or search by relevant keywords. Visit www.bradyeurope.com/tds or click the QR code.

Brady Workstation

Brady Workstation offers professional, intuitive apps to design quality product and cable labels and safety signs. Label design becomes easier, faster and quickly adaptable to new label norms thanks to centralised updates.

Select the apps you need

Simply select the apps you need, download the 30-day trial and purchase when satisfied. Available product, cable, safety and facility identification apps enable you to:

- design and edit custom labels and signs
- design label templates and lock elements for consistency
- create text-only cable labels
- automate label creation
- easily import data
- easily set up complex label sequences
- easily design CLP-chemical labels
- print lockout procedures, tags and energy source labels
- design safety and facility signs.

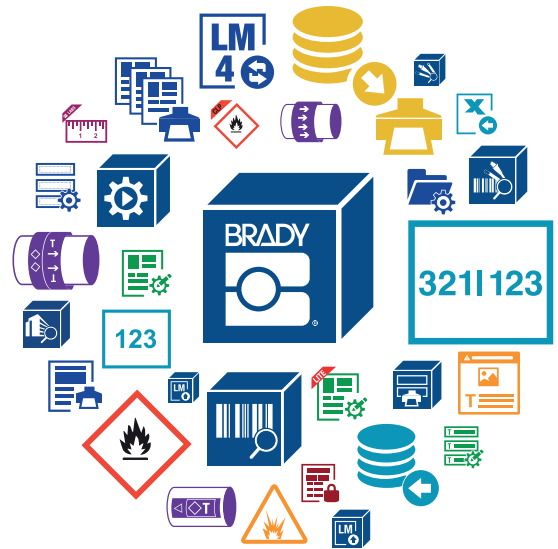

Available in multiple languages

Brady Workstation apps are available in more than 20 languages, including English, French, German, Russian, Spanish, Italian, Polish and Dutch. Select your language before downloading from the drop down menu.

Easily connect to your printer

Brady Workstation works seamlessly with a range of Brady desktop and portable printers. Brady's high-end label printers also offer bi-directional communication with Brady Workstation and will inform users if they have to switch label materials to print specific label designs. Printer compatibility is shown in Brady Workstation on an app by app basis.

Brady Workstation Basic Design Software Suite

Get everyone in your facility up and running quickly on as many computers as you like with this free label creation software! You'll have basic design, formatting, graphics and simple barcode libraries to create labels like a pro!

The Basic Suite is included with every printer, all you need to do is download it. Workstation.BradyID.com/Free



Brady Workstation Product and Wire Identification Software Suite

Quickly identify your products and wires with customised text or graphical labels, using serialised or imported data. Workstation.BradyID.com/ProductandWire



Brady Workstation Safety and Facility Identification Software Suite

Keep your facility safe and compliant by creating custom signs, label and pipemarkers, adding visual safety guidance. Workstation.BradyID.com/SafetyAndFacilityE



Brady Workstation Laboratory Identification Software Suite

Easily identify any sample with the most wanted laboratory sample label design apps in our Brady Workstation Lab suite. Workstation.BradyID.com/lab



| PRINTER | |
|---|--|
| Description | BradyPrinter i3300 Industrial Label Printer |
| Includes | This i3300 printer comes in a cardboard box. It ships with a power cord, a Brady Workstation Suite, a USB cable, a product CD holding the manual, a cleaning kit and a printed quick start guide |
| Applications | Asset tracking, Barcode labelling, Circuit board labelling, Component and equipment labelling, Data and telecommunications labelling, Electrical labelling, Facility identification, General identification, Hazard communication identification, Inventory and inspection labelling, Laboratory labelling, Lean and 5S labelling, Pipe and valve marking, Warehouse marking, Wire and cable labelling |
| Print Resolution (dpi) | 300 dpi |
| Print Speed (mm/sec) | 101.60 mm/s |
| Stand-alone Printing (Detached from PC) | Peripheral |
| Internal Memory | 512 MB RAM, 195 MB IFFS Flash |
| Colour Capability | Monocolour |
| Language Support | Bulgarian, Chinese (Simplified), Chinese (Traditional), Croatian, Czech, Danish, Dutch, English (US), Estonian, Finnish, French (Canada), French, German, Hungarian, Italian, Korean, Norwegian (Bokmål), Polish, Portuguese (Brazil), Portuguese, Romanian, Russian, Spanish (Mexico), Spanish, Swedish, Thai, Turkish |
| Weight (kg) | 5.22 kg |
| Width x Height x Depth (mm) | 228.60 x 241.30 x 304.80 |
| Calibration | No |
| Operating Temperature | 10°C - 40°C |
| Operating Humidity | 10%-85% (RH non-condensing) |
| Storage Temperature | -20° - 50°C |
| Storage Humidity | 15%-90% (RH non-condensing) |
| Warranty | 1 year |
| MEDIA | |
| Continuous vs Die-cut Labels | Continuous and Die-cut |
| Compatible Media | B30-, B30C-, B30EP-, B33-, B33C-, B33D-, B33FP-, B33FT-, B33R- |
| Custom Labels | Yes |
| Number of Stock Parts | 800+ standard parts |
| Materials Supported | Freezerbondz Polyester; Heat-shrink Polyolefin Sleeve; High Temperature Heat-shrink Polyvinylidene Fluoride Sleeve; Magnetic Polyester; Metal Detectable Polyester; Metallic, Non-metal Polyester; Metallised Polyester; Nylon Cloth; Paper; Phosphorescent Polyester; Polyester; Polyester Tag; Polyester with Polyester Overlaminat; Polyethylene Tag; Polyimide; Polyolefin; Polypropylene; Polyvinylfluoride; Reflective Tape; Self-laminating Polyester; Self-laminating Vinyl; StainerBondz Polyester; Tamper-evident Metallised Polyester; Thermoplastic Polyether Polyurethane; Vinyl; Vinyl Cloth |
| Max. Label Width (mm) | 107.95 |
| Min. Label Height (mm) | 6.35 |
| Min. Label Width (mm) | 6.35 |
| Max. Liner Width (mm) | 107.95 |
| Min. Liner Width (mm) | 18.03 |
| Max. Print Width (mm) | 101.98 |
| Recommended Usage per Day | 3000 |

| POWER SUPPLY | |
|----------------------------|---|
| Power Supply | AC Adaptor |
| Power Supply Voltage | 100 - 240 V @ 50 - 60 Hz |
| DISPLAY | |
| Display | Colour LCD Touchscreen |
| Display Resolution | 320 x 240 pixels |
| On Screen Indicators | Supply Remaining, Ribbon Remaining, Ribbon and label part number recognition, WiFi, Ethernet Status, Error Messaging, Data Reception |
| SOFTWARE & CONNECTIVITY | |
| Connectivity Options | Ethernet, USB, USB 2.0, Wi-Fi |
| Software Compatibility | Brady Workstation, Windows based driver for 3rd party software use |
| Programming Language | BPL (Brady Programming Language) |
| FONTS/GRAPHICS/SYMBOLOGIES | |
| Built-in Fonts | Arial, Courier New, Times New Roman, Trechuchet MS, Verdana, Tahoma |
| Bar Code Type | Code 128A, Code 128B, Code 128C, Code 39, Code 93, EAN-13, EAN-8, HIBC, Interleaved 2 of 5, Interleaved 2 of 5 with check digit, JAN-13, JAN-8, UPC-A, Aztec, Data Matrix, MicroPDF417, PDF417, QR code |
| COMPLIANCE | |
| Approval/Compliance | UL; cUL; CE; RoHS; RCM; KCC; EAC |



Learn more about the BradyPrinter i3300 on :

www.bradyeurope.com/i3300



Africa

Randburg, South Africa
Tel.: +27 11 704 3295
Email: africa@bradycorp.com

Benelux

Zele, Belgium
Tel.: +32 (0) 52 45 78 11
Email: benelux@bradycorp.com

Central & Eastern Europe

Bratislava, Slovakia
Tel.: +421 2 3300 4800
Email: central_europe@bradycorp.com

Denmark

Odense
Tel.: +45 66 14 44 00
Email: denmark@bradycorp.com

France

Roncq
Tel.: +33 (0) 3 20 76 94 48
Email: france@bradycorp.com

Germany, Austria & Switzerland

Egelsbach, Germany
Tel.: +49 (0) 6103 7598 660
Email: germany@bradycorp.com

Hungary

Budaörs
Tel.: +36 23 500 275
Email: central_europe@bradycorp.com

Italy

Gorgonzola
Tel.: +39 02 26 00 00 22
Email: italy@bradycorp.com

Middle East FZE

Dubai, UAE
Tel.: +971 4881 2524
Email: cs_me@bradycorp.com

Norway

Kjeller
Tel.: +47 70 13 40 00
Email: norway@bradycorp.com

Spain & Portugal

Madrid, Spain
Tel.: +34 900 902 993
Email: spain@bradycorp.com,
portugal@bradycorp.com

Sweden, Finland, Baltic states

Kista, Sweden
Tel.: +46 (0) 8 590 057 30
Email: sweden@bradyeurope.com

Turkey

Istanbul
Tel.: +90 212 264 02 20 / 264 02 21
Email: turkey@bradycorp.com

UK & Ireland

Banbury, UK
Tel.: +44 (0) 1295 228 288
Email: uk@bradycorp.com

Our mission is to identify and protect people, products and premises



To help minimise our impact on the environment, Brady limits its number of reprints.

Updated versions are always available for download on www.bradyeurope.com.



Search for: EUR-M-055-EN



Y4822185

Your distributor