



Counting Products Guide



DEFENDER™5000



RANGER™COUNT 4000



SCOUT™STX

Ingeniously Practical

Introduction

There are many ways to count, but only Counting Scales offer the best combination of accuracy, ease of setup and cost.

All Counting Scales use the weight of a sample of parts to create an **Average Piece Weight** ("APW") which is then used to count the pieces on the scale by dividing the weight by the APW in memory. The APW can be based on a sample of parts on the pan, or it can be a preset weight value that is entered into the scales' memory.

Counting Scales have a **Displayed Resolution** and an **Internal Counting Resolution**. The Displayed Resolution is based on the **Capacity** of the scale – the total weight it can measure – divided by the smallest weight it can show on the display (the **Readability** of the scale). The Internal Counting Resolution is several times higher than this and is the scale's ability to count using a sample. This resolution is defined by both the **Minimum APW** – the smallest piece weight the scale can support – as well as the **Minimum Sample Weight** – the smallest weight of the sample the scale can use. As a sample can be made up of many pieces, the Minimum APW is always a fraction of the Minimum Sample Weight. Both specifications are used to ensure that the scale you use can precisely count your parts with a low error.

Many OHAUS counting scales and balances include software that will alert you if the Minimum APW or Sample Weight is too light. We also include software that will automatically update the APW (**APW Optimization**) as you continue to count parts, refining the APW as you use the scale. This not only reduces the errors found from miscounting a large sample – you can start with 10 pieces and add more to reach a sample of 100 pieces – but it helps minimize errors from very slight part weight changes over time. Scales with numeric keypads will also allow **Preset APWs** where you already know what the part should weigh and can just punch it into the scale. For a large number of different parts, **Libraries** allow quick recall of information, speeding use.

Whether it is a R&D lab, a parts bin on the shop floor, or a quick inventory check, there is a role for a counting scale in every business. Counting can take place in many areas of a business and is involved in the entire lifecycle of a product from R&D to production and warehousing. OHAUS balances are found in QA/QC labs as well as in production areas – wherever ultra-high precision counting is required, while OHAUS Scales can be used to count skids or totes of parts up to 3 000 kg.

Parts Counting can be done by adding pieces up to a target count into a box, it can be done by Filling to a range of parts in a box, and it can be used to quickly Check – Yes or No — the count of parts in a box in inventory. Counting scales are used for adding parts to a kit for later assembly, for controlling lean manufacturing inventory, as well as for ongoing or annual warehouse inventory audits.

Capacity

The nominal value of the weighing range.

Displayed Resolution

The smallest weight it can show on the display, calculated by taking the capacity of the scale and dividing by the readability.

APW

Average Piece Weight

Internal Counting Resolution

The number of divisions into which it divides the total capacity of the scale.

Minimum APW

Smallest APW that can be determined by the scale

Minimum Sample Weight

Smallest sample required for sampling.

Quick Guide

	RANGER					DEFENDER				BALANCES			
Scale / Balance	Ranger 7000	Ranger Count 4000	Ranger Count 3000	Ranger 4000	Ranger 3000	Defender 5000	Defender 3000	Defender 5000 Floor Scale	Defender 3000 Floor Scale	Explorer	Adventurer	Scout STX	Navigator
Indicator	-			-		TD52P/TD52XW	i-DT33P / i-DT33XW	TD52P/TD52XW	i-DT33P / i-DT33XW	-			
Capacity Range	3 kg - 60 kg	3 kg - 30 kg	1.5 kg - 30 kg	3 kg - 30 kg	1.5 kg - 30 kg	3 kg - 600 kg	15 kg - 600 kg	300 kg - 3 000 kg	600 kg - 3 000 kg	120 g - 35 000 g	120 g - 8 200 g		220 g - 22 000 g
Internal Counting Resolution	Up to 1:7 000 000	1:1 500 000		1:1 500 000		1:600 000	Up to 1:7 500 depending on model	1:600 000	1:3 000	Up to 1:10 200 000 depending on model		Up to 1:2 200 000 depending on model	Up to 1:102 000 depending on model
Check Counting	+ / - / 0			+ / - / 0		+ / - / 0	n/a	+ / - / 0	n/a	+	n/a		
Fill Counting	✓	n/a		n/a		n/a			n/a	✓	n/a		
Sampling	+ / -			+	+	+ / -	+	+ / -	+				
Custom Sample Size	✓		n/a			✓	n/a	✓	n/a	✓		n/a	
APW Optimization	✓		n/a			✓	n/a	✓	n/a	✓		n/a	
APW Auto Optimization Alert	✓		n/a			✓	n/a	✓	n/a				
APW Lo Alert	✓		n/a			✓	n/a	✓	n/a	✓		n/a	
Preset APW	✓		n/a			✓	n/a	✓	n/a	✓		n/a	
APW Auto Save	✓		n/a			✓	n/a	✓	n/a	✓		n/a	
Library Items	2 000	30		n/a		50 000	n/a	50 000	n/a	99	n/a		
Remote / Second Base	Option			Option	n/a	n/a			n/a				
Smart Sampling w/ OHAUS Balance	✓	n/a		n/a		✓	n/a	✓	n/a	Supporting Balance		n/a	
Barcode Scanner Support	✓	n/a		n/a		✓	n/a	✓	n/a	✓	n/a		
ScaleMate Support	✓			✓		✓			n/a				
Barcode Label Printer Support	✓	n/a		n/a		✓			n/a				
Page Finder	6-7	8-9	10-11	12-13	14-15	16-17	18-19	20-21	22-23	24-25	26-27	28-29	30-31

+ / - / 0 means the product can perform positive (into a box), negative (out of a full box) or zero Check Counting.

+ / - means the product can sample either into a box (+ sampling) or out of a full box (- sampling).

"Supporting Balance" means that the product can connect by RS232 to an OHAUS Ranger 7000 or Defender 5000 and provide an ultra-precise APW.



With its 2 000 item library, the commonly used parts information can be stored for fast recall using the keyboard or optional barcode scanner. Counting results can be easily transferred to PC via the RS232/USB/Ethernet interfaces and the parts data in the Ranger 7000 can be maintained using OHAUS

ScaleMate software. With these features, a complete inventory control system can be set up making the Ranger 7000 is the best tool for counting.

In luxury eye glasses manufacturing segment, customers use an OHAUS reference balance for more accurate parts weights for high-cost titanium alloy components. The Ranger 7000 recalculates the APW (Average Piece Weight) during counting, increasing accuracy with each lot. A remote base (like a floor scale platform) with higher capacity can be connected with the optional kit to the Ranger 7000 in order to achieve precise results for large bins and totes of parts.



All the Counting Related Features:

- **Capacity Range:** 3 - 60 kg
- **Internal Counting Resolution:** 1:7 000 000
- **Check Counting:** Positive Check / Negative Check / Zero Check
- **Fill Counting:** ✓
- **Sampling:** Positive Sampling / Negative Sampling
- **Custom Sample Size:** ✓
- **APW Optimization:** ✓
- **APW Auto Optimization Alert:** ✓
- **APW Lo Alert:** ✓
- **Preset APW:** ✓
- **APW Auto Save:**
- **Library Items:** 2 000
- **Remote / Second Base:** Option
- **Smart Sampling w/ OHAUS Balance:** ✓
- **Barcode Scanner Support:** ✓
- **ScaleMate Support:** ✓
- **Barcode Label Printer Support:** ✓
- **Fill Counting:** ✓

RANGER™7000 Counting System

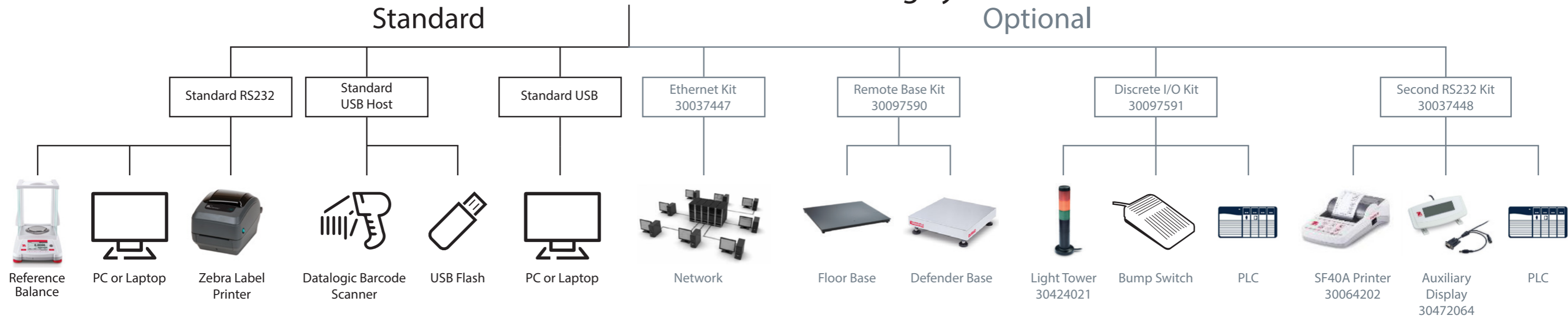

Model	R71MD3	R71MD6	R71MD15	R71MD35	R71MD60	R71MHD3	R71MHD6	R71MHD15	R71MHD35
Capacity x Readability	3 kg × 0.00005 kg 3 000 g × 0.05 g	6 kg × 0.0001 kg 6 000 g × 0.1 g	15 kg × 0.0002 kg 15 000g × 0.2 g	35 kg × 0.0005 kg 35 000 g × 0.5 g	60 kg × 0.001 kg 60 000 g × 1 g	3 kg × 0.00001 kg 3 000 g × 0.01 g	6 kg × 0.00002 kg 6 000 g × 0.02 g	15 kg × 0.0001 kg 15 000 g × 0.1 g	35 kg × 0.0001 kg 35 000 g × 0.1 g
Display Resolution	1:60 000	1:75 000	1:75 000	1:70 000	1:75 000	1:300 000	1:300 000	1:150 000	1:350 000
Internal Counting Resolution	1:1 200 000	1:1 500 000	1:1 500 000	1:1 400 000	1:1 500 000	1:6 000 000	1:6 000 000	1:3 000 000	1:7 000 000
Minimum APW	0.0025 g	0.005 g	0.01g	0.025 g	0.05 g	0.0005 g	0.001 g	0.005 g	
Minimum Sample Weight	1 g	2 g	4 g	10 g	20 g	0.2 g	0.4 g	2 g	
Counting Mode	Counting, Check Counting, Parts Filling								
Interface	Standard RS232, USB Host / Device, Optional Second RS232, Second Scale Kit, Ethernet , 2 in/4 out Discrete I/O								
Construction	Stainless Steel Platform / IP54 Die Cast Housing								
Library	2 000 items								
Platform Dimensions (W x D x H)	280 mm × 280 mm × 31 mm		377 mm × 311 mm × 48 mm			210 mm × 210 mm × 12 mm		377 mm × 311 mm × 48 mm	



The Ranger Count 4000 is widely used in manufacturing for packaging and inventory control where durability, mobility and standard counting resolution is a must. Counting results can be read within one second, improving working efficiency and the full cast metal housing and frame ensure that the Ranger Count 4000 stands up to heavy industrial use. The Ranger Count 4000 stores 30

items in its library for easy recall and the included RS232 interface can be used to connect to a system or printer.

The optional Second RS232, USB or Ethernet kits offer additional connectivity capabilities. A remote base (like a floor scale platform) with higher capacity can be connected with the optional kit in order to achieve precise results for large bins and totes of parts. All these features make Ranger 4000 the durable choice for mobile counting.



All the Counting Related Features:

- **Capacity Range:** 3 - 30 kg
- **Internal Counting Resolution:** 1:1 500 000
- **Check Counting:** Positive Check / Negative Check / Zero Check
- **Sampling:** Positive Sampling / Negative Sampling
- **Custom Sample Size:** ✓
- **APW Optimization:** ✓
- **APW Lo Alert:** ✓
- **Preset APW:** ✓
- **APW Auto Save:** ✓
- **Library Items:** 30
- **Remote / Second Base:** Option
- **ScaleMate Support:** ✓

RANGER™ COUNT 4000 Counting System

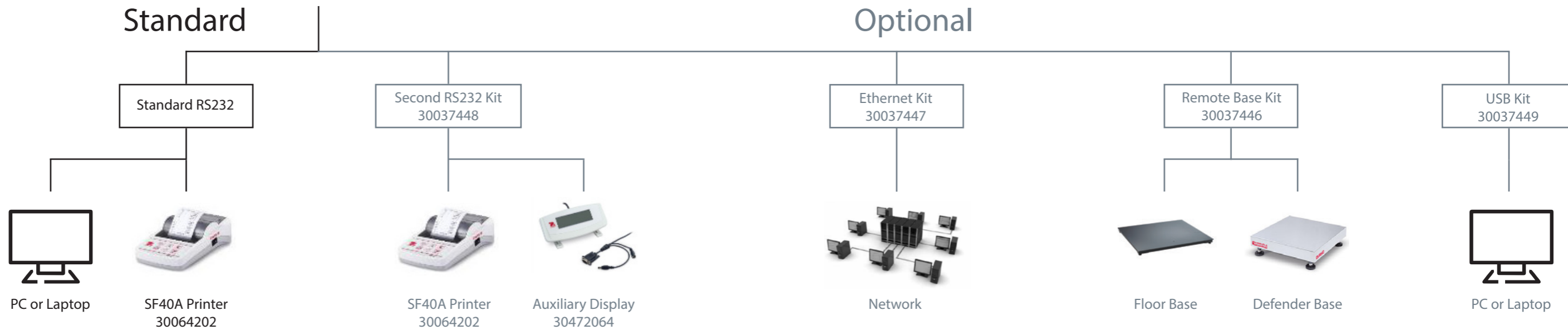

Model	RC41M3	RC41M6	RC41M15	RC41M30
Capacity x Readability	3 kg × 0.0001 kg 3 000 g × 0.1 g	6 kg × 0.0002 kg 6 000 g × 0.2 g	15 kg × 0.0005 kg 15 000 g × 0.5 g	30 kg × 0.001 kg 30 000 g × 1 g
Display Resolution	1:30 000			
Internal Counting Resolution	1:1 500 000			
Minimum APW	0.01 g	0.02 g	0.05 g	0.1 g
Minimum Sample Weight	2 g	4 g	10 g	20 g
Counting Mode	Counting, Check Counting			
Library	30 items			
Platform Dimensions	300 mm × 225 mm			



The Ranger Count 3000 is the economical choice for packaging and inventory control where mobility is a must. Counting results can be read within one second, improving working efficiency and the durable ABS plastic housing and cast metal weighing frame ensure that the Ranger Count 3000 stands up to industrial use. The Ranger Count 3000 stores 30 items in its library for easy recall and the included RS232 interface can be used to connect to a system or printer.

The optional Second RS232, USB or Ethernet kits offer additional connectivity capabilities. A remote base (like a floor scale platform) with higher capacity can be connected with the optional kit in order to achieve

precise results for large bins and totes of parts. All these features make Ranger 3000 the economical choice for counting.



All the Counting Related Features:

- **Capacity Range:** 1.5 - 30 kg
- **Internal Counting Resolution:** 1:1 500 000
- **Check Counting:** Positive Check / Negative Check / Zero Check
- **Sampling:** Positive Sampling / Negative Sampling
- **Custom Sample Size:** ✓
- **APW Optimization:** ✓
- **APW Lo Alert:** ✓
- **Preset APW:** ✓
- **APW Auto Save:** ✓
- **Library Items:** 30
- **Remote / Second Base:** Option
- **ScaleMate Support:** ✓

RANGER™ COUNT 3000 Counting System

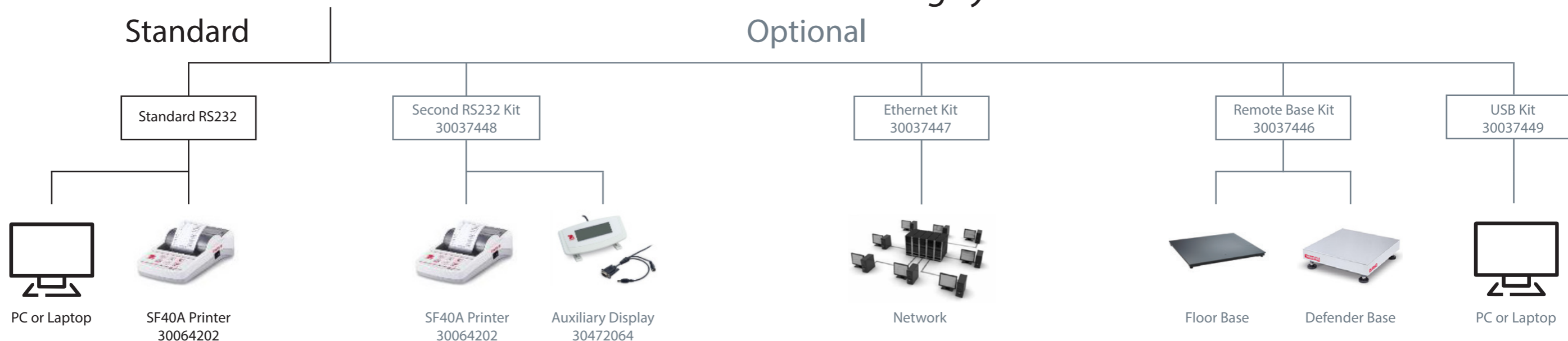

Model	RC31P1502	RC31P3	RC31P6	RC31P15	RC31P30
Capacity x Readability	1.5 kg × 0.00005 kg 1 500 g × 0.05 g	3 kg × 0.0001 kg 3 000 g × 0.1 g	6 kg × 0.0002 kg 6 000 g × 0.2 g	15 kg × 0.0005 kg 15 000 g × 0.5 g	30 kg × 0.001 kg 30 000 g × 1 g
Display Resolution	1:30 000				
Internal Counting Resolution	1:1 500 000				
Minimum APW	0.005 g	0.01 g	0.02 g	0.05 g	0.1 g
Minimum Sample Weight	1g	2g	4g	10g	20g
Counting Mode	Counting, Check Counting				
Library	30 items				
Platform Dimensions	300 mm × 225 mm				

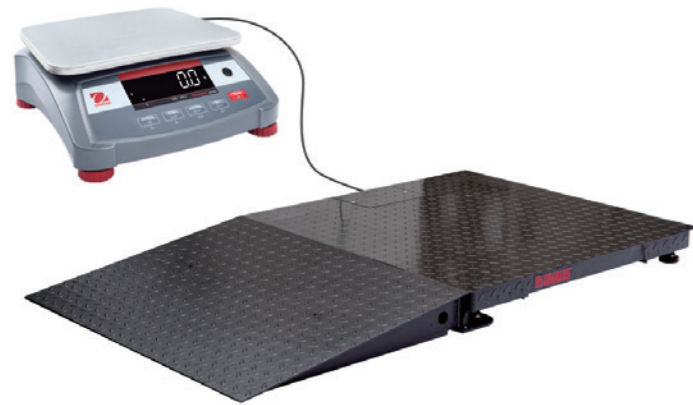

All the Counting Related Features:

- **Capacity Range:** 3 - 30 kg
- **Internal Counting Resolution:** 1:1 500 000
- **Check Counting:** Positive Check / Negative Check / Zero Check
- **Sampling:** Positive Sampling
- **Remote / 2nd Base:** Option
- **ScaleMate Support:** ✓

Ranger 4000 compact scale has seven application modes: Basic Weighing, Percentage Weighing, Parts Counting, Check Weighing/Counting/Percentage, Accumulation, Dynamic Weighing and Display Hold. With its full metal housing, Ranger 4000 can survive in the harsh industrial environment. It's a good tool for your basic counting jobs.

RANGER™ 4000 Counting System

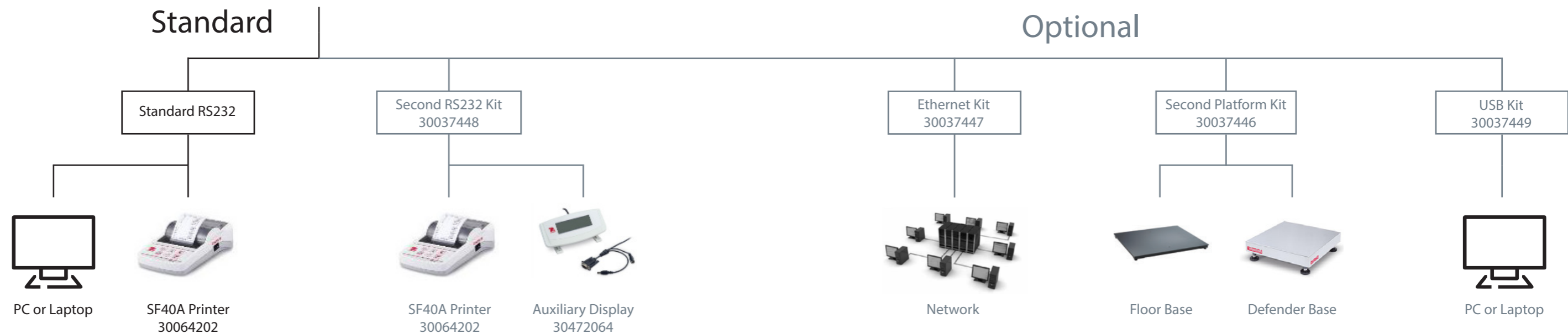

Model	R41M3	R41M6	R41M15	R41M30
Capacity x Readability	3 kg × 0.0001 kg 3 000 g × 0.1 g	6 kg × 0.0002 kg 6 000 g × 0.2 g	15 kg × 0.0005 kg 15 000 g × 0.5 g	30 kg × 0.001 kg 30 000 g × 1 g
Displayed Resolution	1:30 000			
Internal Counting Resolution	1:1 500 000			
Minimum APW	0.01 g	0.02 g	0.05 g	0.1 g
Minimum Sample Weight	2 g	4 g	10 g	20 g
Counting Mode	Counting, Check Counting			
Platform Dimensions	300 mm × 225 mm			



All the Counting Related Features:

- **Capacity Range:** 1.5 - 30 kg
- **Internal Counting Resolution:** 1:1 500 000
- **Check Counting:**
Positive Check / Negative Check / Zero Check
- **Sampling:** Positive Sampling
- **ScaleMate Support:** ✓

Ranger 3000 compact scale has seven application modes: Basic Weighing, Percentage Weighing, Parts Counting, Check Weighing/Counting/Percentage, Accumulation, Dynamic Weighing and Display Hold. It's a good tool for your basic counting jobs.

RANGER™3000 Counting System

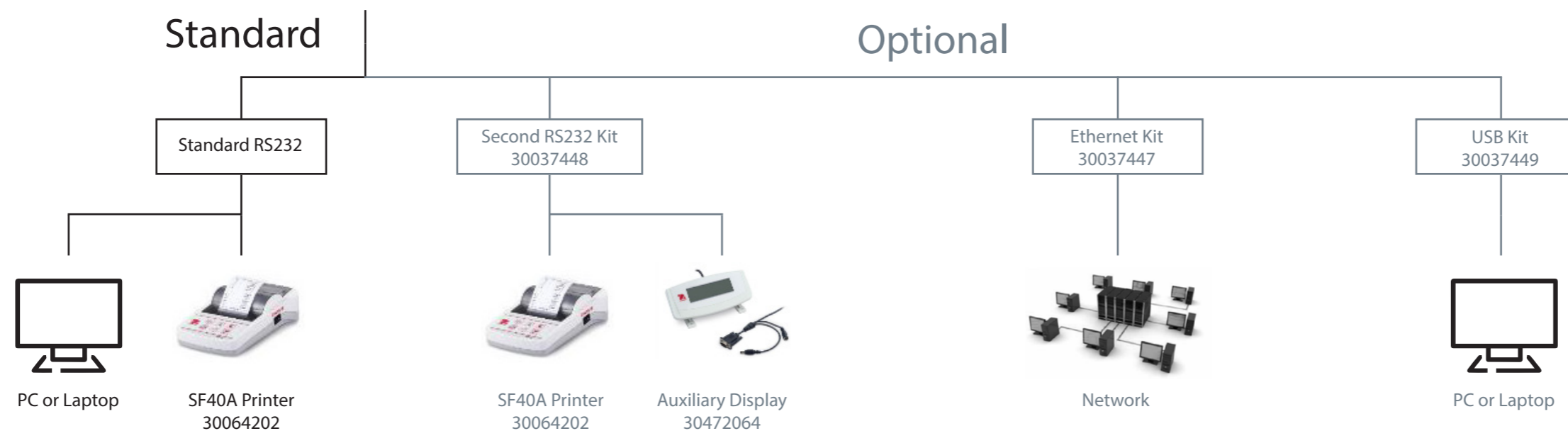

Model	R31P1502	R31P3	R31P6	R31P15	R31P30
Capacity x Readability	1.5 kg × 0.00005 kg 1 500 g × 0.05 g	3 kg × 0.0001 kg 3 000 g × 0.1 g	6 kg × 0.0002 kg 6 000 g × 0.2 g	15 kg × 0.0005 kg 15 000 g × 0.5 g	30 kg × 0.001 kg 30 000 g × 1 g
Displayed Resolution	1:30 000				
Internal Counting Resolution	1:1 500 000				
Minimum APW	0.005 g	0.01 g	0.02 g	0.05 g	0.1 g
Minimum Sample Weight	1 g	2 g	4 g	10 g	20 g
Counting Mode	Counting, Check Counting				
Platform Dimensions	300 mm × 225 mm				



Industries like machinery manufacturing run on handling a wide range of parts and assemblies, from small lots in parts bins up to totes and skids in the warehouse. Not only are parts often expensive, requiring cost control, but the wrong set of parts can bring the assembly line to a halt.

Combining a high counting resolution with capacities up to 600 kg, multiple connectivity options, and all-steel construction, the Defender 5000 bench scale is an idea solution for the manufacturing industry. For light or high-cost parts,

the Defender 5000 can pull sample weights from an ultra-precision balance or use known part information in memory. For the needs of complex industrial applications, the Defender 5000 is an excellent combination of strength and brains.



All the Counting Related Features:

- **Capacity Range:** 3 - 600 kg
- **Internal Counting Resolution:** 1:600 000
- **Check Counting:** Positive Check / Negative Check / Zero Check
- **Sampling:** Positive Sampling / Negative Sampling
- **Custom Sample Size:** ✓
- **APW Optimization:** ✓
- **APW Auto Optimization Beep:** ✓
- **APW Lo Alert:** ✓
- **Preset APW:** ✓
- **APW Auto Save:** ✓
- **Library Items:** 50 000
- **Smart Sampling w/ OHAUS Balance:** ✓
- **Barcode Scanner Support:** ✓
- **ScaleMate Support:** ✓
- **Barcode Label Printer Support:** ✓
- **Fill Counting:** ✓

DEFENDER™5000 Counting System

Standard

Optional

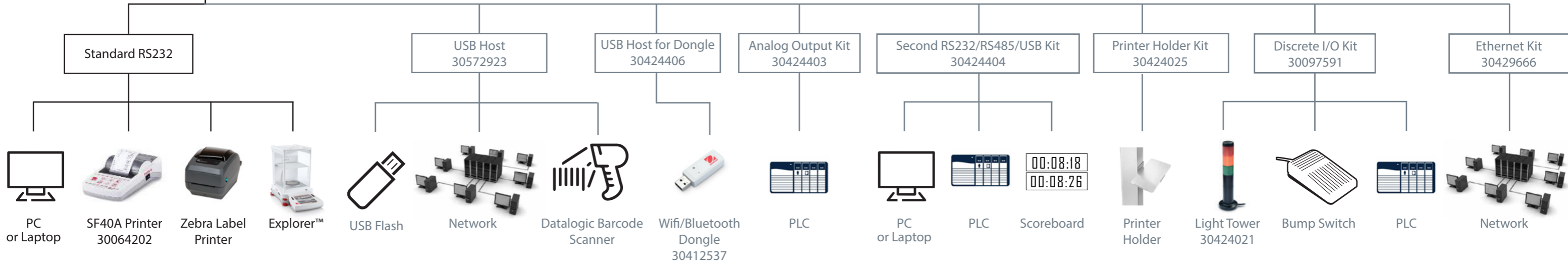

Model	D52P6RQDR1 D52P6RQDR5	D52P15RQDR1 D52P15RQDR5	D52P15RQDL2 D52P15RQDL5	D52P30RQDL2 D52P30RQDL5	D52P60RQDL2 D52P60RQDL5	D52P60RQDX2 D52P60RQDX5	D52P150RQDX2 D52P150RQDX5	D52P60RQDV3	D52P150RQDV3	D52P300RQDV3	D52P150RTDV3	D52P300RTDV3	D52P600RTDV3	
Capacity x Readability	3/6 kg x 0.2/0.5 g	6/15 kg x 0.5/1 g		15/30 kg x 1/2 g	30/60 kg x 2/5 g		60/150 kg x 5/10 g	30/60 kg x 2/5 g	60/150 kg x 5/10 g	150/300 kg x 10/20 g	60/150 kg x 5/10 g	150/300 kg x 10/20 g	300/600 kg x 20/50 g	
Display Resolution	2 x 15 000 d													
Internal Counting Resolution	1:600 000													
Minimum APW	0.01 g	0.025 g		0.05 g	0.1 g		0.25 g	0.1 g	0.25 g	0.5 g	0.25 g	0.5 g	1g	
Minimum Sample Weight	4 g	10 g		20 g	40 g		100 g	40 g	100 g	200 g	100 g	200 g	400 g	
Counting Mode	Counting, Check Counting													
Platform Dimensions	305 mm x 305 mm		400 mm x 400 mm			500 mm x 500 mm			610 mm x 610 mm			600 mm x 800 mm		



The Defender 3000 Series bench scales are ideal for general weighing, simple counting and checkweighing applications in production, packaging, warehouse, inventory, shipping and receiving areas. The Defender 3000 Series features a simple, yet rugged tubular-frame base design and indicators with tactile keys, multicolor backlit LCD display, AC or battery operation and flexible mounting capabilities.



All the Counting Related Features:

- **Capacity Range:** 15 - 600 kg
- **Internal Counting Resolution:** 1:75 000
- **Check Counting:**
Positive Check / Negative Check / Zero Check
- **Sampling:**
Positive Sampling / Negative Sampling
- **ScaleMate Support:** ✓
- **Barcode Label Printer Support:** ✓

DEFENDER™3000 Counting System

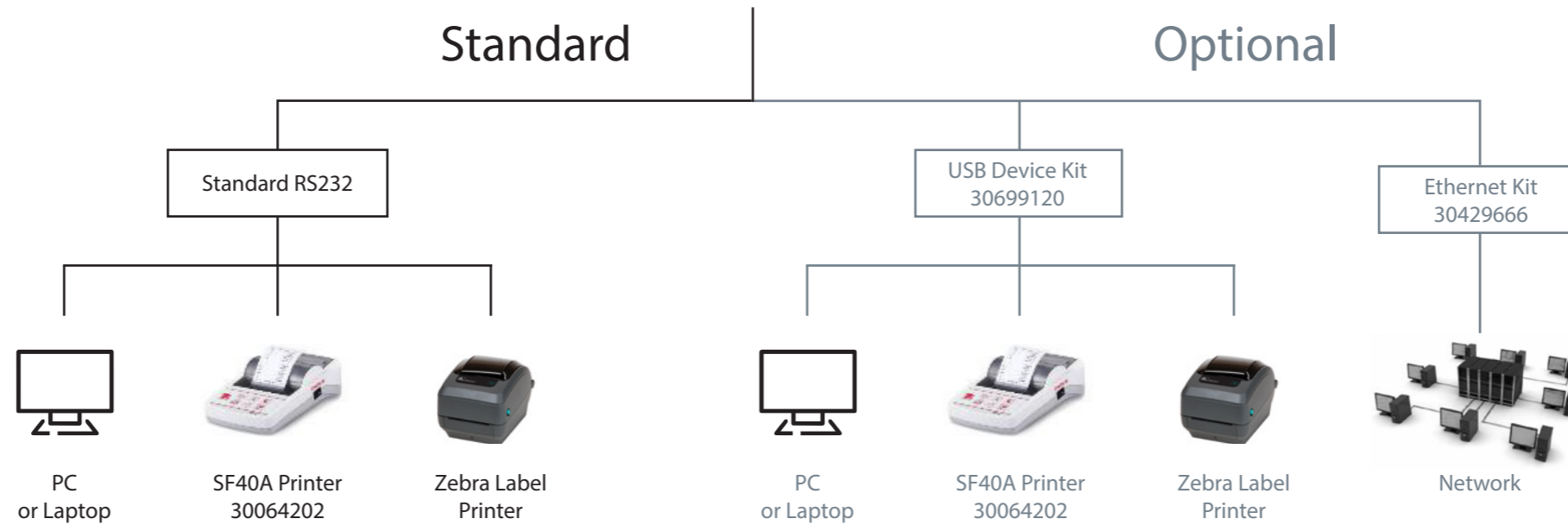

Model	i-D33P15B1R1 i-D33P15B1R5	i-D33P30B1R1 i-D33P30B1R5	i-D33P60B1R1 i-D33P60B1R5	i-D33P60B1L2 i-D33P60B1L5	i-D33P150B1L2 i-D33P150B1L5	i-D33P150B1X2 i-D33P150B1X5	i-D33P300B1X2 i-D33P300B1X5	i-D33P300B1V3	i-D33P600B1V3
Capacity x Readability	15 kg x 2 g	30 kg x 5 g	60 kg x 10 g		150 kg x 20 g		300 kg x 50 g		600 kg x 100 g
Display Resolution	1:6 000				1:7 500	1:7 500		1:6 000	
Internal Counting Resolution	1:6 000				1:75 000	1:7 500		1:6 000	
Minimum APW	0.2 g	0.5 g	1 g		2 g		5 g		10 g
Minimum Sample Weight	40 g	100 g	200 g		400 g		1 000 g		2 000 g
Counting Mode	Counting								
Platform Dimensions	305 mm x 355 mm			420 mm x 550 mm		500 mm x 650 mm		600 mm x 800 mm	



The OHAUS Defender 5000 Series Floor Scale is a solid lineup of floor and pit mount scales that do not compromise on quality for industrial applications. Powered by four IP68 hermetically sealed load cells that will withstand years of daily usage in industrial environments, these scales offer a unique combination of affordability, versatility and quality that your company can depend on for years and years.



All the Features Related with Counting:

- **Capacity Range:** 300 - 3 000 kg
- **Internal Counting Resolution:** 1:600,000
- **Check Counting:** Positive Check / Negative Check / Zero Check
- **Sampling:** Positive Sampling / Negative Sampling
- **Custom Sample Size:** ✓
- **APW Optimization:** ✓
- **APW Auto Optimization Beep:** ✓
- **APW Lo Alert:** ✓
- **Preset APW:** ✓
- **APW Auto Save:** ✓
- **Library Items:** 50,000
- **Smart Sampling w/ OHAUS Balance:** ✓
- **Barcode Scanner Support:** ✓
- **Barcode Label Printer Support:** ✓
- **Fill Counting:** ✓

DEFENDER™5000 Floor Scales Counting System

Standard

Optional

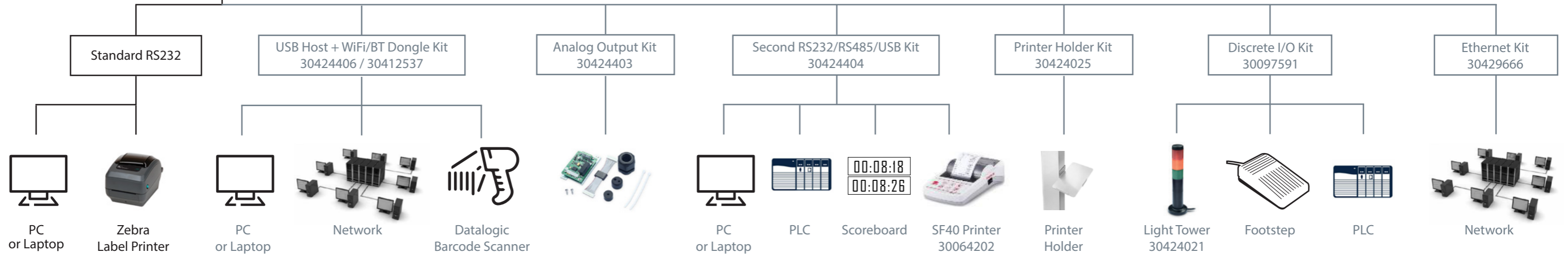

Model	DF52P300F1S DF52XW300G1S	DF52P600F1S DF52XW600G1S	DF52P300F1R DF52XW300G1R	DF52P600F1R DF52XW600G1R	DF52P1500F1R DF52XW1500G1R	DF52P600F1LX DF52XW600G1LX	DF52P1500F1LX DF52XW1500G1LX	DF52P3000F1LX DF52XW3000G1LX	DF52P600F1X DF52XW600G1X	DF52P1500F1X DF52XW1500G1X	DF52P3000F1X DF52XW3000G1X	DF52P1500F1XV	DF52P3000F1XV
Capacity x Readability	300 kg x 0.05 kg	600 kg x 0.1 kg	300 kg x 0.05 kg	600 kg x 0.1 kg	1 500 kg x 0.2 kg	600 kg x 0.1 kg	1 500 kg x 0.2 kg	3 000 kg x 0.5 kg	600 kg x 0.1 kg	1 500 kg x 0.2 kg	3 000 kg x 0.5 kg	1 500 kg x 0.2 kg	3 000 kg x 0.5 kg
Display Resolution	Up to 7 500d depending on model												
Internal Counting Resolution	1:120 000												
Minimum APW	2.5 g	5 g	2.5 g	5 g	10 g	5 g	10 g	25 g	5 g	10 g	25 g	10 g	25 g
Minimum Sample Weight	1 kg	2 kg	1 kg	2 kg	4 kg	5 g	10 g	25 g	5 g	10 g	10 kg	4 kg	10 kg
Counting Mode	Counting, Check Counting												
Platform Dimension	800 mm x 800 mm		1 000 mm x 1 000 mm			1 250 mm x 1 500 mm			1 500 mm x 1 500 mm			1 500 mm x 2 000 mm	



All the Features Related with Counting:

- **Capacity Range:** 600 - 3 000 kg
- **Internal Counting Resolution:** 1:3 000
- **Check Counting:**
Positive Check / Negative Check / Zero Check
- **Sampling:**
Positive Sampling / Negative Sampling
- **ScaleMate Support:** ✓
- **Barcode Label Printer Support:** ✓

Defender 3000 Series Floor Scales are the value solution for wet and dry weighing needs in industrial & commercial applications. Their high-quality material and construction are designed to minimize distortion under heavy loads, and ensure years of dependable performance. Available with corresponding ramps and mounting accessories, Defender 3000 floor scales offer a unique combination of value, quality and dependability that you can rely on.

DEFENDER™3000 Floor Scales Counting System

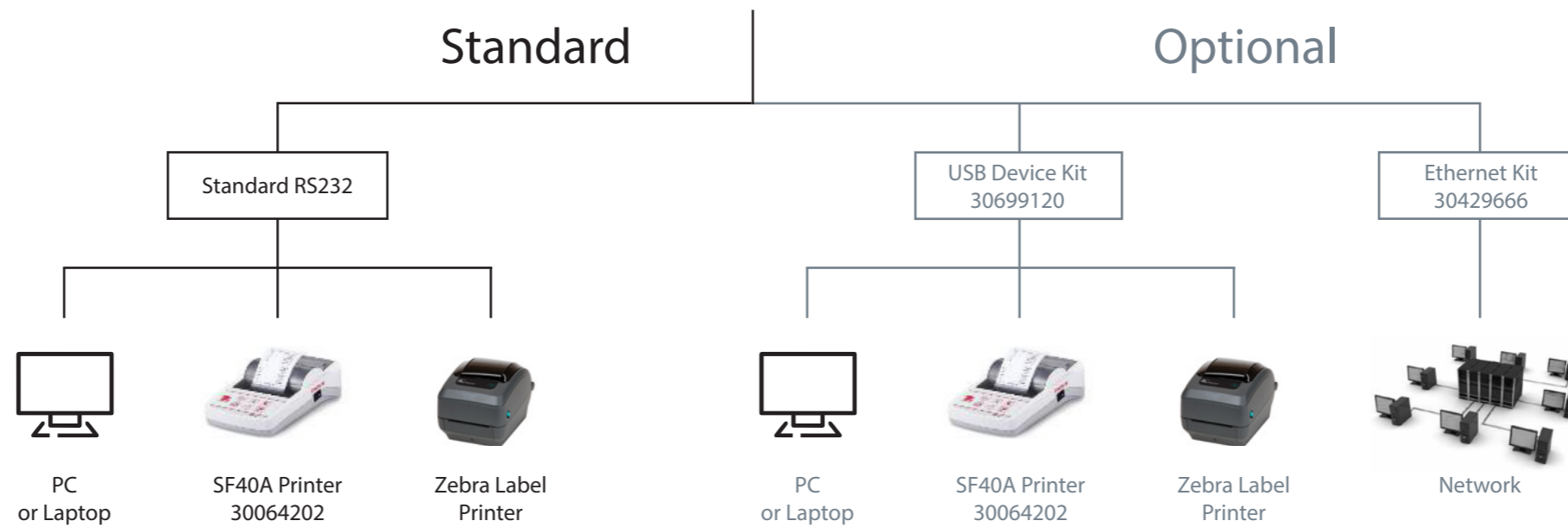

Model	i-DF33P600B1R i-DF33XW600C1R	i-DF33P1500B1R i-DF33XW1500C1R	i-DF33P1500B1L i-DF33XW1500C1L	i-DF33P3000B1L i-DF33P3000C1L	i-DF33P1500B1X i-DF33XW1500C1X	i-DF33P3000B1X i-DF33XW3000C1X
Capacity x Readability	600 kg x 0.2 kg	1 500 kg x 0.5 kg		3 000 kg x 1 kg	1 500 kg x 0.5 kg	3 000 kg x 1 kg
Display Resolution	3 000d					
Internal Counting Resolution	1:3 000					
Minimum APW	0.02 kg	0.05 kg		0.1 kg	0.05 kg	0.1 kg
Minimum Sample Weight	4 kg	10 kg		20 kg	10 kg	20 kg
Counting Mode	Counting					
Platform Dimension	1 000 mm x 1 000 mm		1 250 mm x 1 250 mm		1 500 mm x 1 500 mm	



Many industries, like those using expensive titanium parts in aerospace, need to combine the power of an analytical balance with the counting abilities of a bench scale to keep costs under control and accurately track inventory. Our best balance, the Explorer, has the ability to resolve part APWs down to 0.001mg, bringing ultra precision to inventory control and warehousing. The Ranger 7000 and Defender 5000 can instantly combine with the

Explorer balance to provide one of the most powerful counting systems on the market. Once connected using the RS232 ports, the APW information from the OHAUS Explorer can be instantly read by the Ranger 7000 or Defender 5000, combining ultra precision with bulk weighing.

On its own, the Explorer gives you all the features of a standard counting scale in a balance – quick APW enhancement, manual entry of known APW values, intuitive Check Counting with preset limits, and storage of up to 99 items in memory. The Explorer also provides the ability to guide Filling by Count to within +/- 1 piece, with a Filling bar display that switches when the Fill is above 90% of the target to show even more precisely the range between 90% and 100% of the target.



All the Counting Related Features:

- **Capacity Range:** 120 - 35,000 g
- **Check Counting:** Positive Check
- **Fill Counting:** ✓
- **Sampling:** Positive Sampling
- **Custom Sample Size:** ✓
- **APW Optimization:** ✓
- **APW Lo Alert:** ✓
- **Preset APW:** ✓
- **APW Auto Save:** ✓
- **Library Items:** 99
- **Smart Sampling w/ OHAUS Balance:** Supporting Balance
- **Barcode Scanner Support:** ✓



EXPLORER™ Counting System

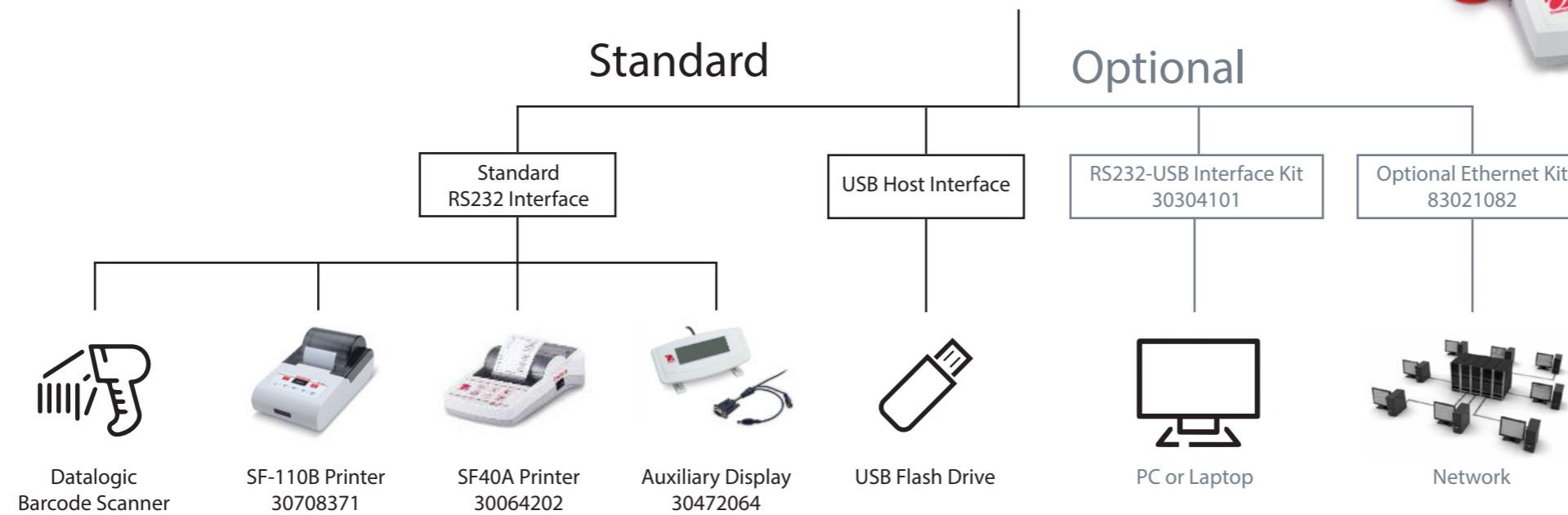

Model	EX2202	EX4202	EX6202	EX10202	EX6201	EX10201	EX12001	EX24001	EX35001
ExCal	EX2202/E	EX4202/E	EX6202/E	-	-	-	-	-	-
Capacity x Readability	2 200 g x 0.01 g	4 200 g x 0.01 g	6 200 g x 0.01 g	10 200 g x 0.01 g	6 200 g x 0.1g	10 200 g x 0.1 g	12 000 g x 0.1 g	24 000 g x 0.1 g	35 000 g x 0.1 g
Display Resolution	1:220 000	1:420 000	1:620 000	1:1 020 000	1:62 000	1:102 000	1:120 000	1:240 000	1:350 000
Internal Counting Resolution	1:2 200 000	1:4 200 000	1:6 200 000	1:10 200 000	1:620 000	1:1 020 000	1:1 200 000	1:2 400 000	1:3 500 000
Sample Size	1 – 10 000 pieces								
Minimum APW	0.001 g			0.01 g			0.01g		
Library	99 items								
Pan Size	190 mm x 200 mm				377 mm x 311 mm				

Model	EX125	EX225/AD	EX124	EX224	EX324	EX223	EX423	EX623	EX1103
ExCal	-	-	-	-	-	EX223/E	EX423/E	-	-
Capacity x Readability	120 g x 0.01 mg	220 g x 0.01 mg	120 g x 0.1 mg	220 g x 0.1 mg	320 g x 0.1 mg	220 g x 1 mg	420 g x 1 mg	620 g x 1 mg	1 100 g x 1 mg
Display Resolution	1:12 000 000	1:22 000 000	1:1 200 000	1:2 200 000	1:3 200 000	1:220 000	1:420 000	1:620 000	1:1 100 000
Internal Counting Resolution	1:120 000 000	1:220 000 000	1:12 000 000	1:22 000 000	1:32 000 000	1:2 200 000	1:4 200 000	1:6 200 000	1:11 000 000
Sample Size	1 – 10 000 pieces								
Minimum APW	0.001 mg		0.01 mg			0.1 mg			
Library	99 items								
Pan Size	Ø 80 mm		Ø 90 mm			Ø 130 mm			



All the Counting Related Features:

- **Capacity Range:** 120 - 520 g
- **Check Counting:** Positive Check / Negative Check / Zero Check
- **Sampling:** Positive Sampling
- **Smart Sampling w/ OHAUS Balance:** Option

Counting is more than just an Industrial application. When it comes to high-value components, such as screws made from titanium alloy, a high-resolution balance must be used.

High strength, good rigidity and lightweight make the cost of titanium alloy much more expensive than steel and aluminum. In order to avoid waste and cost increase during packaging, precise counting work for this kind of high-value components is required by manufacturers.

ADVENTURER™ AX Counting System

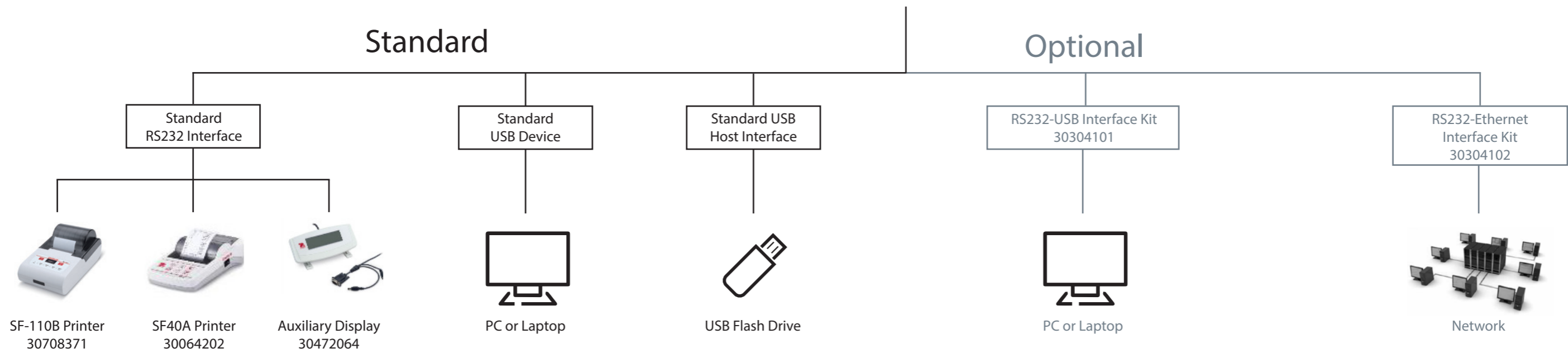

Model	AX124	AX224	AX324	AX223	AX423	AX523
Capacity x Readability	120 g × 0.0001 g	220 g × 0.0001 g	320 g × 0.0001 g	220 g × 0.001 g	420 g × 0.001 g	520 g × 0.001 g
Display Resolution	1:1 200 000	1:2 200 000	1:3 200 000	1:220 000	1:420 000	1:520 000
Internal Counting Resolution	1:12 000 000	1:22 000 000	1:32 000 000	1:2 200 000	1:4 200 000	1:5 200 000
Sample Size	1 – 10 000 pieces					
Minimum APW	0.1 mg / 0.00001g			0.1 mg / 0.0001g		
Pan Size	Ø 90 mm			Ø 130 mm		



Scout STX sets new standards in laboratory and industrial weighing. Thanks to the big, colour touchscreen, operating the Scout is so intuitive that your customers won't even need to read the manual. Moreover it has 10 times capacity rated overload protection which makes balance durable in demanding environment. 9 built in application modes make even the most complex weighing tasks easy to perform. From check weighing and parts counting to shipping and receiving, trust the Scout for accurate and reliable results.



All the Counting Related Features:

- **Capacity Range:** 120 - 8,200 g
- **Internal Counting Resolution:** Up to 1:2,200,000
- **Sampling:** Positive Sampling
- **APW Optimization:** ✓
- **APW Lo Alert:** ✓
- **Preset APW:** ✓
- **Smart Sampling w/ OHAUS Balance:** Supporting Balance

SCOUT™STX Counting System

Optional



Model	STX123	STX223	STX222	STX422	STX622	STX1202
Capacity x Readability	120 g × 0.001 g	220 g × 0.001 g	220 g × 0.01 g	420 g × 0.01 g	620 g × 0.01 g	1 200 g × 0.01 g
Display Resolution	120 000	220 000	22 000	42 000	62 000	120 000
Internal Counting Resolution	1:1 200 000	1:2 200 000	1:220 000	1:420 000	1:620 000	1:1 200 000
Minimum APW (g)	0.0001 g		0.001 g			
Minimum Sample Weight	0.02 g		0.2 g			
Pan Size	Ø93 mm		Ø120 mm		170 mm × 140 mm	

Model	STX2202	STX421	STX621	STX2201	STX6201	STX8200
Capacity x Readability	2 200 g × 0.01 g	420 g × 0.1 g	620 g × 0.1 g	2 200 g × 0.1 g	6 200 g × 0.1 g	8 200 g × 1 g
Display Resolution	220 000	4 200	6 200	22 000	62 000	8 200
Internal Counting Resolution	1:2 200 000	1:42 000	1:62 000	1:220 000	1:620 000	1:82 000
Minimum APW (g)	0.001 g	0.01 g			0.1 g	
Minimum Sample Weight	0.2 g	2 g			20 g	
Pan Size	170 mm × 140 mm	Ø120 mm	170 mm × 140 mm			



Ruggedly constructed and multifunctional, the Navigator is a powerful balance that can handle a diverse range of weighing applications with features such as fast stabilization time, overload protection at four times its rated capacity and easy operation. Navigator is ideal to be used in light to medium duty industrial applications, including paint and ink mixing, packaging, sampling and parts counting.



All the Counting Related Features:

- **Capacity Range:** 220 - 22,000 g
- **Internal Counting Resolution:** Up to 1:62,000
- **Sampling:** Positive Sampling

NAVIGATOR™ Counting System

Optional

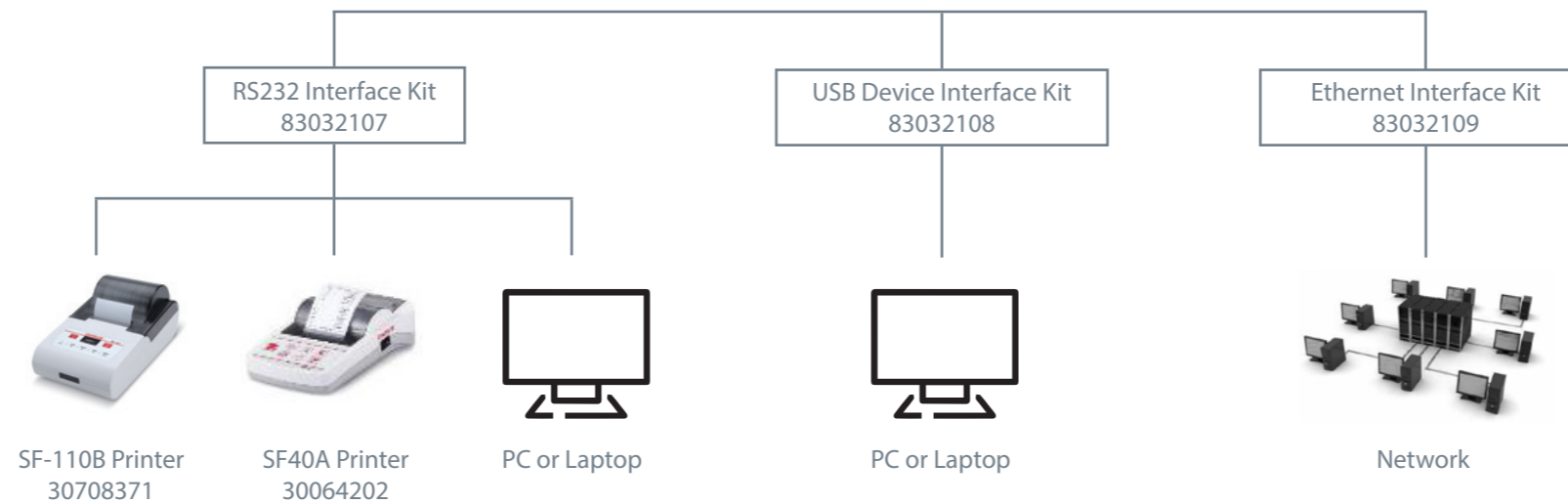

Model	NV222	NV422	NV622	NV221	NV621	NV1201	NV2201
Capacity x Readability	220 g × 0.01 g	420 g × 0.01 g	620 g × 0.01 g	220 g × 0.1 g	620 g × 0.1 g	1 200 g × 0.1 g	2 200 g × 0.1 g
Display Resolution	22 000	42 000	62 000	2 200	6 200	12 000	22 000
Internal Counting Resolution	1:22 000	1:42 000	1:62 000	1:2 200	1:6 200	1:12 000	1:22 000
Minimum APW (g)	0.01 g			0.1 g			
Minimum Sample Weight	0.2 g			2 g			
Platform Dimensions	Ø145 mm			190 mm × 144 mm			

Model	NVT2201	NVT4201	NVT6201	NVT2200	NVT6200	NVT12000	NVT22000
Capacity x Readability	2 200 g × 0.1 g	4 200 g × 0.1 g	6 200 g × 0.1 g	2 200 g × 1 g	6 200 g × 1 g	12 000 g × 1 g	22 000 g × 1 g
Display Resolution	22 000	42 000	62 000	2 200	6 200	12 000	22 000
Internal Counting Resolution	1:22 000	1:42 000	1:62 000	1:2 200	1:6 200	1:12 000	1:22 000
Minimum APW (g)	0.1 g			1 g			
Minimum Sample Weight	2 g			20 g			
Platform Dimension	230 mm × 174 mm						

FAQs

1. How Can I Sample Precisely?

- Sample and count the same part – do not mix parts
- Make sure your sample comes from different times in your production cycle
- Make sure your part does not change due to moisture
- Dirt and oil will affect the accuracy of part counts
- Check your APW periodically – once a shift or once a day – to ensure that your part weight has not changed.
- Use Auto Optimization to ensure that the sample of parts is large enough to average out any differences in weights – 100 pieces in a sample is a good rule of thumb
- Use the most precise scale to ensure that your counts are accurate

2. How Can Barcoding Save Time?

Using a barcode scanner with part information already in a Ranger 7000 's or Defender 5000's library memories ensures that the box tare weight and part APW are recalled quickly and accurately each time, eliminating loss from inputting the wrong weights. A barcode label printer not only can print a fast label with the part barcode on it, it can also add information on the date and time, the part name and the net weight of the package, taking handwritten errors out of the equation. Using barcoding overall can eliminate operator errors, reduce loss and costs, and increase the accuracy of the information you are giving your customers.

3. Why Do We Need a Reference Balance?

With the reference balance, we can get a much more precise average piece weight than a regular counting scale can produce, which leads to a more accurate counting result. It's commonly used to count the small, light, high value parts.

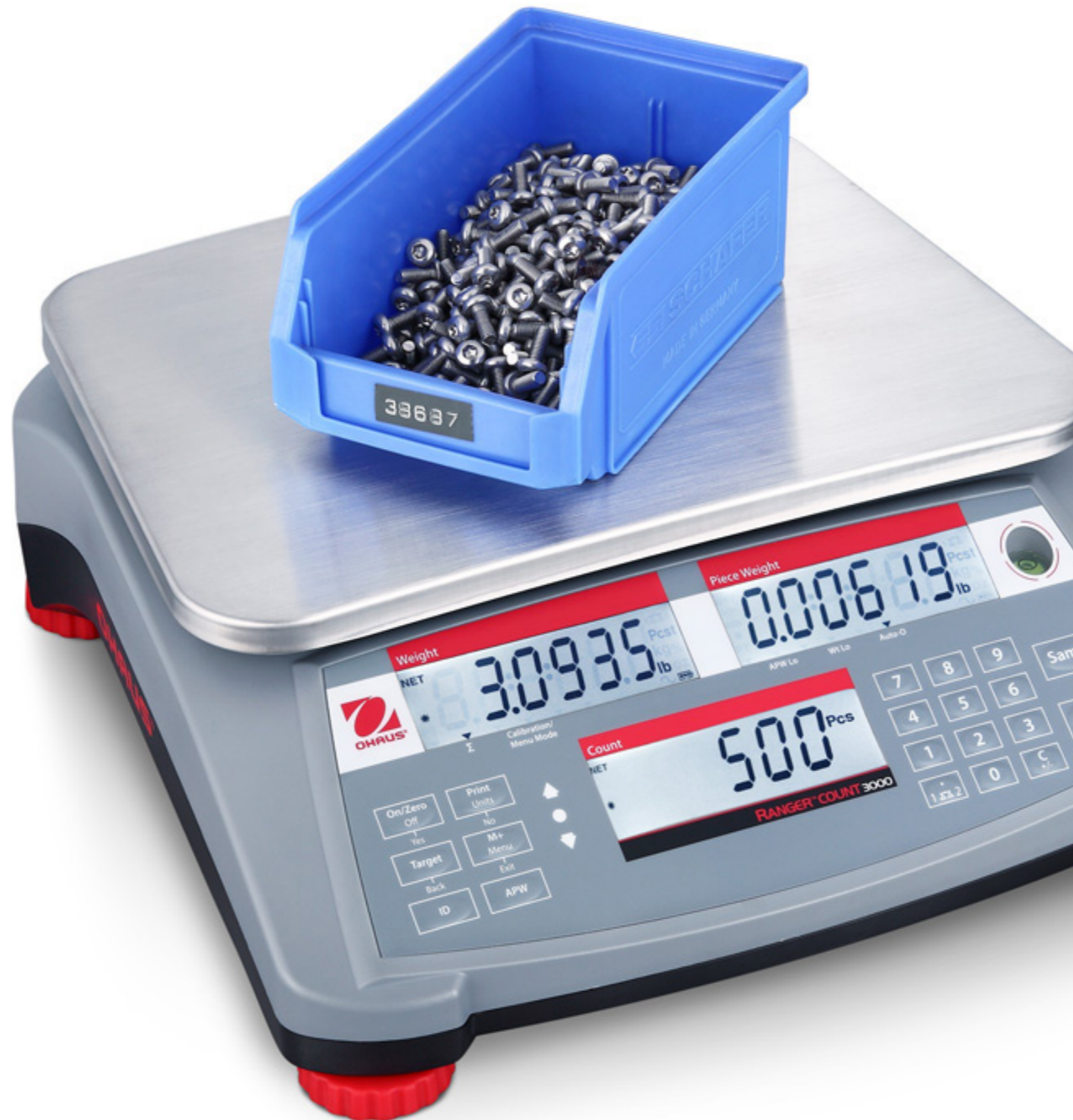

Choose the Right Counting Scale

- **What is the weight of the lightest part?**
The lightest part should be x 2 the minimum APW
- **How much do the boxes weigh (parts plus box)?**
The capacity of the scale should be x 2 the heaviest box
- **How big is the largest box you will be using?**
Scales can range from 17 x 14 cm all the way to 150 x 200 cm
- **Where will the scale be used—on a bench or floor?**
Higher capacity bases are usually used on the floor
- **How rough is the environment?**
Look for metal housings and thick stainless steel pans
- **Do you need battery power?**
Battery powered scales are great for portable use
- **Do you need to count on more than one platform?**
If you do, look for a Remote Base or Second Scale connections
- **Do you need to store information on multiple parts?**
Get more memories than the number of parts you have
- **Do you need a barcode reader and/or label printer?**
Barcode systems increase speed and accuracy of counts

Where Can You Use Counting Scales?

- Fastener and metal parts manufacturing
- Plastic parts injection molding lines
- Parts bins, in-process inventory locations
- Warehouses and distribution hubs
- Production lines and assembly areas
- Wholesale and retail locations
- Foodservice and catering halls
- Hardware stores, plumbing supply houses
- any place that you count, you will need a counting scale!

Ranger Accessories

RANGER™7000

	PN	Accessory
	30064202	SF40A Printer
	80500525	RS232 Cable
	30097590	Remote Base Kit
	83021085	USB Cable (Type A to B)
	30037447	Ethernet Kit
	30097591	Discrete I/O Kit
	30424021	Light Tower
	30037448	Second RS232 Kit
	30472064	Auxiliary Display AD7 - RS
	30095408	Painted Column Kit
	30101495	Cable Extension Kit, 9 m
	30041295	Rechargeable Battery
	30057595	Cable for Reference Balance
	30708371	SF-110B Printer

RANGER™3000

	PN	Accessory
	30064202	SF40A Printer
	80500525	RS232 Cable
	30037447	Ethernet Kit
	30037448	Second RS232 Kit
	30037449	USB Kit
	30708371	SF-110B Printer

RANGER™COUNT 3000

	PN	Accessory
	30064202	SF40A Printer
	80500525	RS232 Cable
	30037446	Remote Base Kit
	30037447	Ethernet Kit
	30037448	Second RS232 Kit
	30037449	USB Kit
	30708371	SF-110B Printer

Ranger Accessories

RANGER™4000

	PN	Accessory
	30064202	SF40A Printer
	80500525	RS232 Cable
	30037446	Remote Base Kit
	30037447	Ethernet Kit
	30037448	Second RS232 Kit
	30037449	USB Kit
	30708371	SF-110B Printer

RANGER™COUNT 4000

	PN	Accessory
	30064202	SF40A Printer
	80500525	RS232 Cable
	30037446	Remote Base Kit
	30037447	Ethernet Kit
	30037448	Second RS232 Kit
	30037449	USB Kit
	30708371	SF-110B Printer

Defender Accessories

DEFENDER™5000

	PN	Accessory
	30064202	SF40A Printer
	30572923	USB Host
	30424406	USB Host for Dongle
	30412537	WiFi/BT Dongle Kit
	30424403	Analog Output Kit
	30424404	Second RS232 /RS485/USB Kit
	30097591	Discrete I/O Kit
	30429666	Ethernet Kit
	30424025	Printer Holder Kit
	30057595	Cable for Reference Balance
	30424409	LC Extension Cable, 9 m
	30372146	Wheel Kit Defender Series
	30616409	Wheel Kit SST Defender Series
	30424405	Battery Kit, Li-ion

	PN	Accessory
	30708371	SF-110B Printer

DEFENDER™3000





	PN	Accessory
	30064202	SF40A Printer
	30372146	Wheel Kit, Defender Series
	30616409	Wheel Kit SST Defender Series
	30429666	Ethernet Kit
	30699120	USB Device Kit i-DT33
	80500525	Cable RS232 i-DT33P
	80500552	Cable RS232 i-DT33XW
	30708371	SF-110B Printer

Floor Scale Accessories

DEFENDER™5000 Floor Scales

	PN	Accessory
	80500525	RS232 Cable
	80500552	RS232 Cable TxxXW
	30097591	Discrete I/O Kit
	30424021	Light Tower
	30472064	Auxiliary Display AD7 - RS
	30057595	Cable for Reference Balance
	30412537	WiFi/Bluetooth Dongle Kit
	30424403	Analog Output Kit, TD52
	30424404	2nd RS232/RS485/USB Kit, TD52
	30424405	Battery Kit, Li-ion, TD52
	30424406	USB Host Kit for Dongle
	30424409	LC Extension Cable, 9m
	30708371	SF-110B Printer

DEFENDER™5000 Floor Scales Continued





	PN	Accessory
	30429666	Ethernet kit
	30064202	SF40A Printer
	30539553	Floor Column Stainless Steel
	30531244	Floor Column Painted Steel
	30708371	SF-110B Printer

DEFENDER™3000 Floor Scales

	PN	Accessory
	30064202	SF40A Printer
	30429666	Ethernet Kit
	30699120	USB Device Kit i-DT33
	80500525	Cable RS232 i-DT33P
	80500552	Cable RS232 i-DT33XW
	30708371	SF-110B Printer

Lab Balance Accessories

EXPLORER™

	PN	Accessory
	30064202	SF40A Printer
	30472064	Auxiliary Display AD7 – RS
	30304101	RS232-USB Interface Kit
	83021082	Optional Ethernet Kit
	30708371	SF-110B Printer

ADVENTURER™

	PN	Accessory
	30064202	SF40A Printer
	30472064	Auxiliary Display AD7 – RS
	30304101	RS232-USB Interface Kit
	30304102	RS232-Ethernet Interface Kit
	83021085	Cable, USB Interface (Type A to B)
	30708371	SF-110B Printer

SCOUT™STX

	PN	Accessory
	30268982	RS232 Interface Kit
	30268983	USB Host Interface Kit
	30268984	USB Device Interface Kit
	30268985	Bluetooth Interface Kit
	30268986	Ethernet Interface Kit
	30472063	Auxiliary Display, AD7-MD
	30708371	SF-110B Printer

NAVIGATOR™

	PN	Accessory
	30064202	SF40A Printer
	83032107	RS232 Interface Kit
	83032108	USB Device Interface Kit
	83032109	Ethernet Interface Kit
	30708371	SF-110B Printer



OHAUS Corporation

Headquartered in Parsippany, New Jersey, OHAUS Corporation is a global leader in manufacturing an extensive line of weighing products, laboratory equipment and analytical instruments that meet and surpass the weighing and measurement needs of a broad range of industries, including laboratory, industrial, educational, food preparation and retail markets. An ISO 9001:2015 manufacturer, OHAUS develops products that are precise, reliable, affordable and backed by industry-leading customer support.

Visit www.OHAUS.com for more information

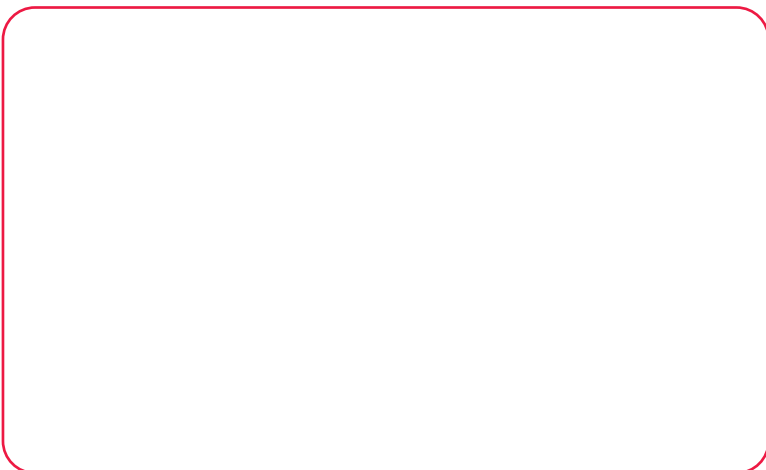

OHAUS Europe GmbH

Heuwinkelstrasse 3,
8606 Nänikon,
Switzerland

e-mail: ssc@ohaus.com

Tel: 0041 22 567 53 19

e-mail: tsc@ohaus.com

Tel: 0041 22 567 53 20

www.ohaus.com

The management system governing the manufacture of this product is ISO 9001:2015 certified.

80776614_C 20230320 © Copyright OHAUS Corporation

